

Technical Survey of Nitrogen
Removal Alternatives for the Deer
Island Treatment Plant

Massachusetts Water Resources Authority

Environmental Quality Department
Report 2013-02



Bigornia-Vitale, G, Wu, D. 2013. *Technical Survey of Nitrogen Removal Alternatives for the Deer Island Treatment Plant*. Boston: Massachusetts Water Resources Authority. Report 2013-02. 35 p.

***Technical Survey Of Nitrogen Removal Alternatives for the
Deer Island Treatment Plant***

Updated by:

Grace Bigornia-Vitale

David Wu

Massachusetts Water Resources Authority
Environmental Quality Department
100 First Avenue
Boston, MA 02129

March 2013
Technical Report 2013-02

Contents

Executive Summary	1
Section 1. Introduction	3
1.1 Purpose of Report.....	3
1.2 Content of Report.....	3
Section 2. Basic Planning Criteria.....	4
2.1 Existing Facilities	4
2.2 Available Space	4
2.3 Flows and Loads.....	8
2.3.1 Flows.....	8
2.3.2 Nitrogen Loads.....	11
2.4 Basic Design Information.....	15
2.4.1 Wastewater Temperature	15
2.4.2 Design Flows and Nitrogen Loads.....	15
2.4.3 Required Effluent Quality	17
Section 3. Screening of Alternatives	18
3.1 Physical/Chemical Processes	18
3.2 Biological Processes	19
3.2.1 Suspended Growth Systems	19
3.2.2 Fixed Growth Systems	20
3.2.3 Hybrid Systems	21
3.2.4 Treatment Innovations	22
3.3 Systems Retained for Further Evaluation	23
Section 4. Evaluation of Alternatives.....	24
4.1 Biological Aerated Filters and Submerged Packed-Bed Reactors.....	24
4.2 Biological Aerated Filters and Fluidized-Bed Reactors	25
4.3 Moving-Bed Biofilm Reactors	25
4.4 Common Elements.....	34
4.4.1 Oxygen Requirement	34
4.4.2 Chemical Requirements.....	34
4.4.3 Sludge Processing	34
4.5 Recommendations for Future Considerations.....	34
4.5.1 Separate Treatment at the Residuals Processing Plant.....	35
4.5.2 Side Stream Treatment at Deer Island Treatment Plant	35
4.5.3 Decreasing Requirement for Methanol.....	35

List of Figures and Tables

Figure 1. Deer Island site plan.....	5
Table 1. Facilities at Deer Island Treatment Plant.....	6
Figure 2. Areas available for nutrient removal.....	7
Figure 3. Deer Island Treatment Plant process flow diagram.....	9
Figure 4. Daily average flow.....	10
Figure 5. Monthly average flow.....	10
Table 2. Summary of nitrogen monitoring results.....	12
Figure 6. Total nitrogen mass balance (April 2005-June 2011).....	13
Figure 7. Total nitrogen load to primary clarifiers.....	14
Figure 8. Total nitrogen load from plant effluent streams.....	14
Figure 9. North System influent temperatures.....	16
Figure 10. South System influent temperatures.....	16
Figure 11. Final effluent temperatures.....	17
Table 3. Flows and nitrogen loads.....	17
Table 4. Alternatives for controlling nitrogen at the Deer Island Treatment Plant.....	23
Table 5. Systems for further evaluation.....	23
Table 6. Biological Aerated Filter for nitrification and Submerged Packed-Bed Reactors for denitrification.....	26
Figure 12. Proposed BAF and SPBR layout.....	27
Table 7. Biological Aerated Filter for nitrification and Fluidized Bed Reactors for denitrification..	28
Figure 13. Proposed BAF and FBR layout.....	29
Table 8. Moving Bed Biofilm Reactor for nitrification.....	31
Table 9. Moving Bed Biofilm Reactor for denitrification.....	32
Figure 14. Proposed MBBR nitrification/denitrification layout.....	33

Executive Summary

Section 8.e.i of MWRA's NPDES discharge permit (No. MA0103284) requires MWRA to "maintain a comprehensive technical survey of effective treatment technologies for nitrogen removal which are applicable to the Deer Island treatment facility." The purpose of the survey is to "facilitate the speedy selection and implementation of nitrogen removal technology if necessary."

The requirement for the survey grows out of concern about the possible impacts of nitrogen, a nutrient, on the Massachusetts Bay ecosystem. Worries that the additional nitrogen in effluent might lead to low dissolved oxygen or undesirable algal blooms in the Bay prompted the inclusion of the above clauses in the permit. Should MWRA need to cut down on nitrogen discharges, the survey will allow MWRA to quickly make an informed decision on available removal options.

This report updates reports submitted in November 2001,¹ June 2003,² February 2004,³ October 2004,⁴ December 2005,⁵ January 2007,⁶ December 2007,⁷ December 2008,⁸ February 2010,⁹ February 2011¹⁰ and January 2012.¹¹ The design criteria for the selection of alternative treatment remain unchanged and are based on their suitability at Deer Island, process reliability, and land and space requirements.

¹ Camp Dresser and McKee, *Technical Survey of Nitrogen Removal Technologies for the Deer Island Treatment Plant*, July 2001.

² Massachusetts Water Resources Authority, *Technical Survey of Nitrogen Removal Technologies for the Deer Island Treatment Plant*, June 2003.

³ Massachusetts Water Resources Authority, *Technical Survey of Nitrogen Removal Technologies for the Deer Island Treatment Plant*, February 2004.

⁴ Massachusetts Water Resources Authority, *Technical Survey of Nitrogen Removal Technologies for the Deer Island Treatment Plant*, October 2004.

⁵ Massachusetts Water Resources Authority, *Technical Survey of Nitrogen Removal Technologies for the Deer Island Treatment Plant*, December 2005.

⁶ Massachusetts Water Resources Authority, *Technical Survey of Nitrogen Removal Technologies for the Deer Island Treatment Plant*, January 2007.

⁷ Massachusetts Water Resources Authority, *Technical Survey of Nitrogen Removal Technologies for the Deer Island Treatment Plant*, December 2007.

⁸ Massachusetts Water Resources Authority, *Technical Survey of Nitrogen Removal Technologies for the Deer Island Treatment Plant*, December 2008.

⁹ Massachusetts Water Resources Authority, *Technical Survey of Nitrogen Removal Technologies for the Deer Island Treatment Plant*, February 2010.

¹⁰ Massachusetts Water Resources Authority, *Technical Survey of Nitrogen Removal Technologies for the Deer Island Treatment Plant*, February 2011.

¹¹ Massachusetts Water Resources Authority, *Technical Survey of Nitrogen Removal Technologies for the Deer Island Treatment Plant*, January 2012.

Approximately 13 acres of usable area exist for siting potential nitrogen removal facilities. This area would allow for the construction of nitrogen removal facilities without significantly encroaching on the landforms that were constructed to mitigate noise and visual impacts on the Town of Winthrop.

No new advances in nitrogen removal technology have emerged since the last report. The latest process which was reported in the last report is based on the partial nitrification of ammonium to nitrite combined with anaerobic ammonium oxidation. However, these new processes target the removal of nitrogen from wastewater containing high quantities of ammonium, such as sludge. At present, the alternatives previously identified in earlier reports appear to be still the most viable options at Deer Island.

Results of nitrogen monitoring conducted for the period July 2005 to June 2012 support the assumptions and estimates used in the original evaluation of treatment options. All three alternatives presented in the earlier studies are still found to be viable options at the Deer Island site. These treatment alternatives are biological aerated filters with submerged packed-bed reactors, biological aerated filters with fluidized-bed reactors, and moving-bed biofilm reactors. The evaluation consisted of sizing and siting facilities based on available space and wastewater flows and loads at the Deer Island Treatment Plant.

Biological nitrogen removal technologies appear to be the most cost-effective method of nitrogen removal at this time. A research project entitled *Sustainable Technology for Achieving Very Low Nitrogen and Phosphorus Effluent Levels*,¹² funded by the Water Environment Research Foundation (WERF), assessed a variety of technologies to determine the feasibility and cost benefits of nutrient reduction at treatment plants around the nation. WERF has yet to release the document. In addition, the US Environmental Protection Agency (EPA) released a reference document¹³ that presented information on recent advances in nutrient removal technology and practices. MWRA will continue to monitor progress and advances in nitrogen removal technologies for applicability to Deer Island.

¹² Water Environment Research Foundation, *Progress*, vol. 14(2), Spring 2003.

¹³ US Environmental Protection Agency, *Municipal Treatment Removal Technologies Reference Document*, September 2008.

Section 1. Introduction

1.1 Purpose of Report

MWRA's NPDES permit requires maintenance of a comprehensive technical survey of nitrogen removal technologies that are applicable to the Deer Island Treatment Plant. This report updates the previous report, *Technical Survey of Nitrogen Removal Technologies for the Deer Island Treatment Plant*, released in February 2011. This update will help to facilitate selection and implementation of nitrogen removal technology if such technology is required at Deer Island.

1.2 Content of Report

This report describes existing conditions at the Deer Island site, and identifies and evaluates various treatment alternatives capable of providing nitrogen removal at the Deer Island facility.

Section 2 begins with a description of existing facilities and of the remaining space available at Deer Island for siting nitrogen removal facilities. Section 2 also presents the most current nitrogen monitoring data available and updates estimates of flows and nitrogen loads used in the previously submitted reports.

Section 3 discusses processes available for nitrogen removal. This section summarizes physical/chemical nitrogen removal and biological nitrification and denitrification technologies. Processes are evaluated for applicability to the Deer Island site, and viable alternatives are selected for a more in-depth review.

Section 4 investigates the alternatives selected in Section 3 for further review. Each alternative is sized to determine feasibility of implementation. Elements common to all three options, such as oxygen and chemical needs and sludge production, are evaluated separately. Section 4 also lists other considerations that should be evaluated in the selection of treatment alternatives.

Section 2. Basic Planning Criteria

This section reviews existing facilities and identifies available space that could be used for nitrogen removal facilities. In addition, this section summarizes July 2001 – June 2011 nitrogen monitoring, updates flows and nitrogen loads from the previous year’s report, and presents basic information used for selecting facilities.

2.1 Existing Facilities

The Deer Island Treatment Plant (DITP) is a pure oxygen activated sludge process treatment plant with an average design flow of 361 mgd and hydraulic capacity of 1270 mgd. During wet weather, the secondary process can treat up to a maximum of 700 mgd. Figure 1 depicts the DITP site layout and Table 1 lists major facilities and pertinent information regarding those facilities.

2.2 Available Space

Nitrogen removal would require additional facilities for wastewater treatment and solids processing. The goal of this analysis is to site these facilities in areas previously allocated for treatment processes or support facilities that were not built, and to avoid construction on the landforms developed to lessen the impact of wastewater treatment facilities on Winthrop.

Areas available for nitrogen removal facilities are highlighted on Figure 2 and include:

- Area A: 5.7 acres, the space west of the existing secondary batteries
- Area B: 0.4 acres, the area to the north of the secondary clarifiers
- Area C: 3.2 acres, the area north of secondary Batteries B, C, and D
- Area D: 3.5 acres, the area located north of the maintenance dry storage warehouse

While the total available gross area is 12.8 acres, piping and operational considerations limit the use of available space and each option with its particular design requirements needs more in-depth evaluation for its feasibility. Section 4 presents these conceptual design evaluations.

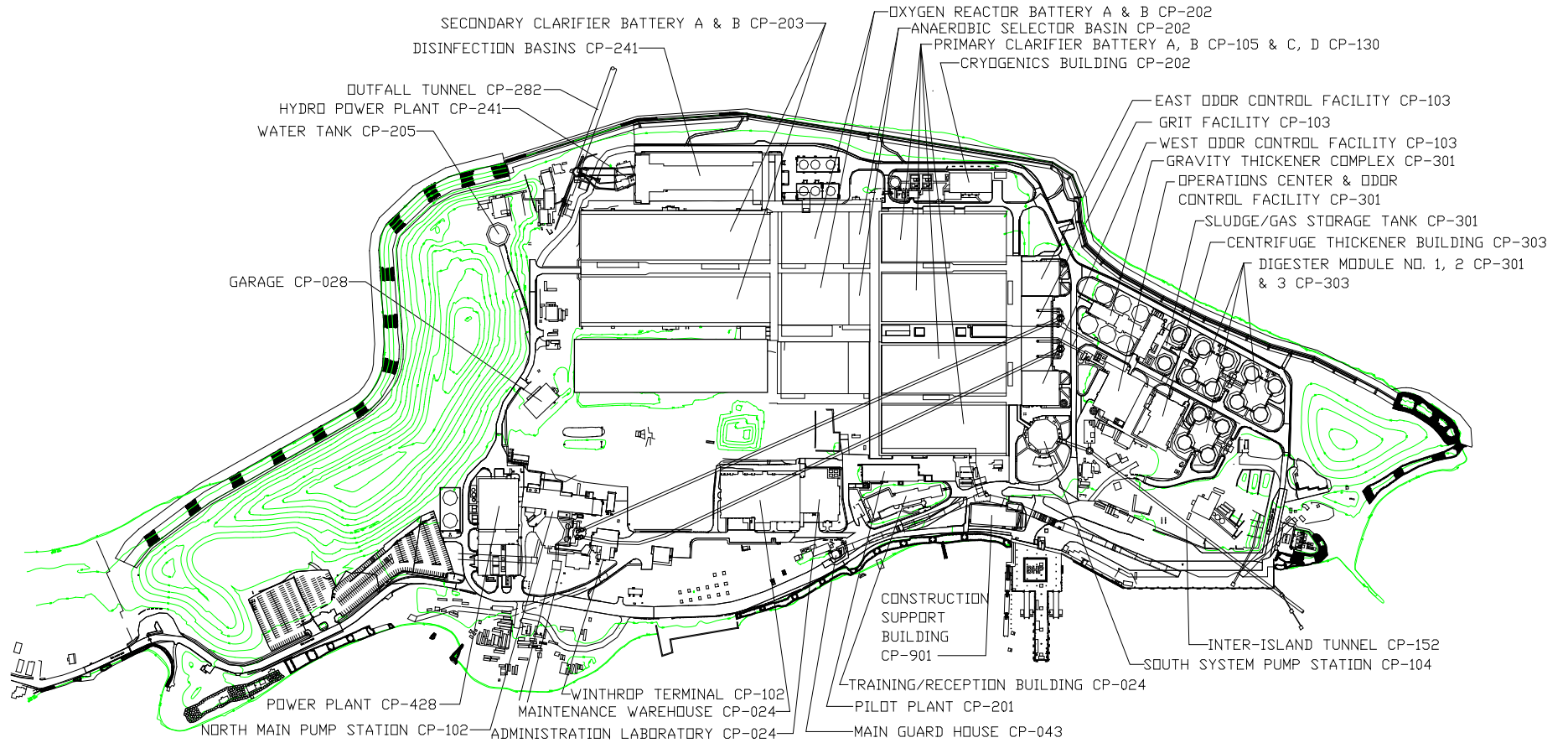
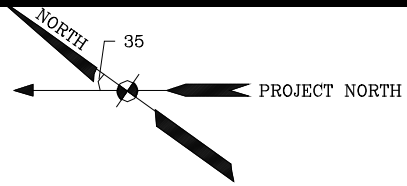

Figure 1. Deer Island Site Plan

Table 1. Facilities at Deer Island Treatment Plant

Stacked Rectangular Primary Clarifiers	
Number of batteries	4
Clarifiers per battery (stacked sets)	12
Effective surface area per clarifier (ft ²)	15,252
Aeration Tanks	
Number of batteries	3
Number of trains per battery	3
Total number of trains	9
Number of stages for selectors	3/train
Volume of selectors per train (MG)	1.07
Number of aeration stages per train	4
Aeration volume per train (MG)	3.55
Stacked Rectangular Secondary Clarifiers	
Number of batteries	3
Clarifiers per battery (stacked sets)	18
Effective surface area per clarifier (ft ²)	13,940
Gravity Thickeners (for Primary Sludge)	
Number of units	6
Diameter (ft)	70
Sidewater depth (ft)	12
Centrifuges for Thickening Waste Activated Sludge	
Number	12
Allowable range flow/centrifuge (gpm)	300 to 900
Anaerobic Digesters/Thickened Sludge Storage	
Number of digesters	12
Volume of each digester (MG)	3.0
Number of storage tanks	2
Diameter (ft)	90
Total depth (ft)	130
Volume each (MG)	3.0

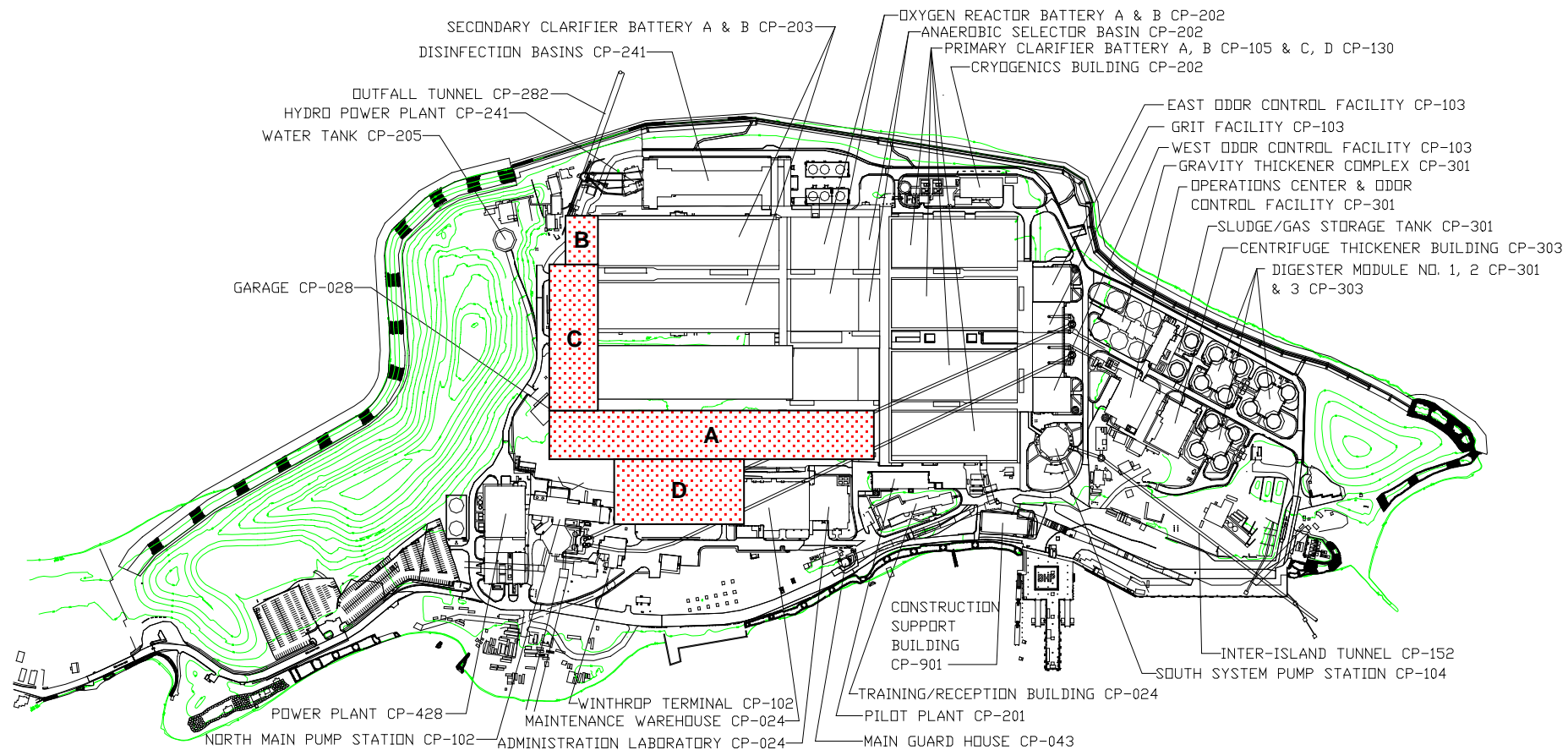
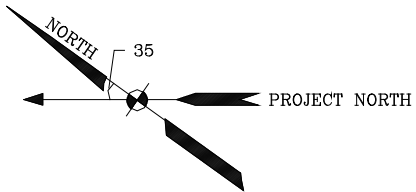

Figure 2. Areas available for nutrient removal

2.3 Flows and Loads

This section provides a summary of monitoring results conducted during the period July 2005 to June 2012 and quantifies nitrogen loads from various wastewater streams. These new load calculations update the estimates that were used in developing and sizing the conceptual designs of the selected nitrogen removal alternatives in the July 2001 report.

In addition to the required NPDES permit influent and effluent monitoring, MWRA implemented a comprehensive nitrogen monitoring program.¹⁴ The program aims to characterize wastewater streams within the treatment plant. Data will facilitate the selection, and if necessary, the design of nitrogen removal facilities at Deer Island.

Figure 3 shows the Deer Island process flow and the various sampling locations along the process. South system flow arrives at the Deer Island's south system pump station via the inter-island tunnel and combines with the north system flow after the grit removal facility. This combined daily flow of raw wastewater is characterized by taking the flow-weighted average of the individual north and south system measurements.

2.3.1 Flows

The average daily flow for the period July 2005 to June 2012 was 360 mgd. This flow and the maximum sustainable flow to secondary of 700 mgd (based on experiments conducted from October 2005 to June 2006), will be used to size nitrogen removal facilities at Deer Island. Figure 4 shows the daily effluent flow while Figure 5 graphs the monthly averages.

Previously, return streams from sludge processing at Deer Island were pumped back to the head of the primary clarifier. These waste streams include overflow from the gravity thickeners, centrate from waste sludge centrifuges, and centrate from the digested sludge centrifuges. However, gravity thickener overflow can go to the primary tanks or to the south system pump station depending on pump availability. As of April 1, 2005, digested sludge is no longer thickened at Deer Island but instead sent to the Residuals Pelletizing Plant in Quincy via the inter-island tunnel. Thus, the only constant internal return stream from on-site residual processing that is pumped back to the head of the primary clarifier is the waste sludge centrate. Mass balance calculations reflect these operational changes. Sludge centrate overflow averages about 5.1 mgd. While this flow can be considered negligible compared to the raw influent, its nitrogen load is high.

¹⁴ Coughlin, Kelly, *Combined Work/Quality Assurance Project Plan for Nitrogen Monitoring in Deer Island Treatment Plant Waste Streams*, ENQUAD report 2000-16, October 2000.

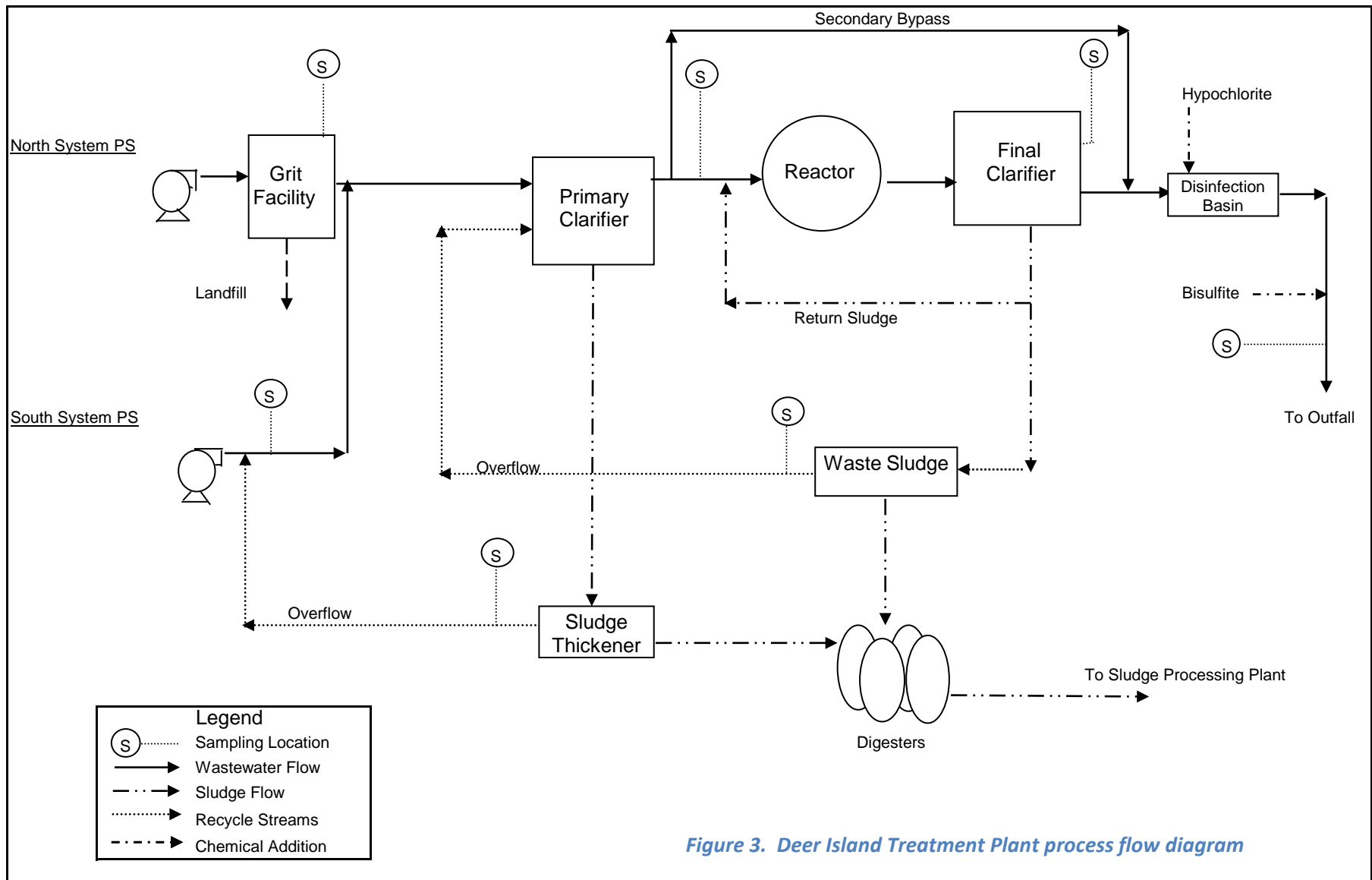

Figure 3. Deer Island Treatment Plant process flow diagram

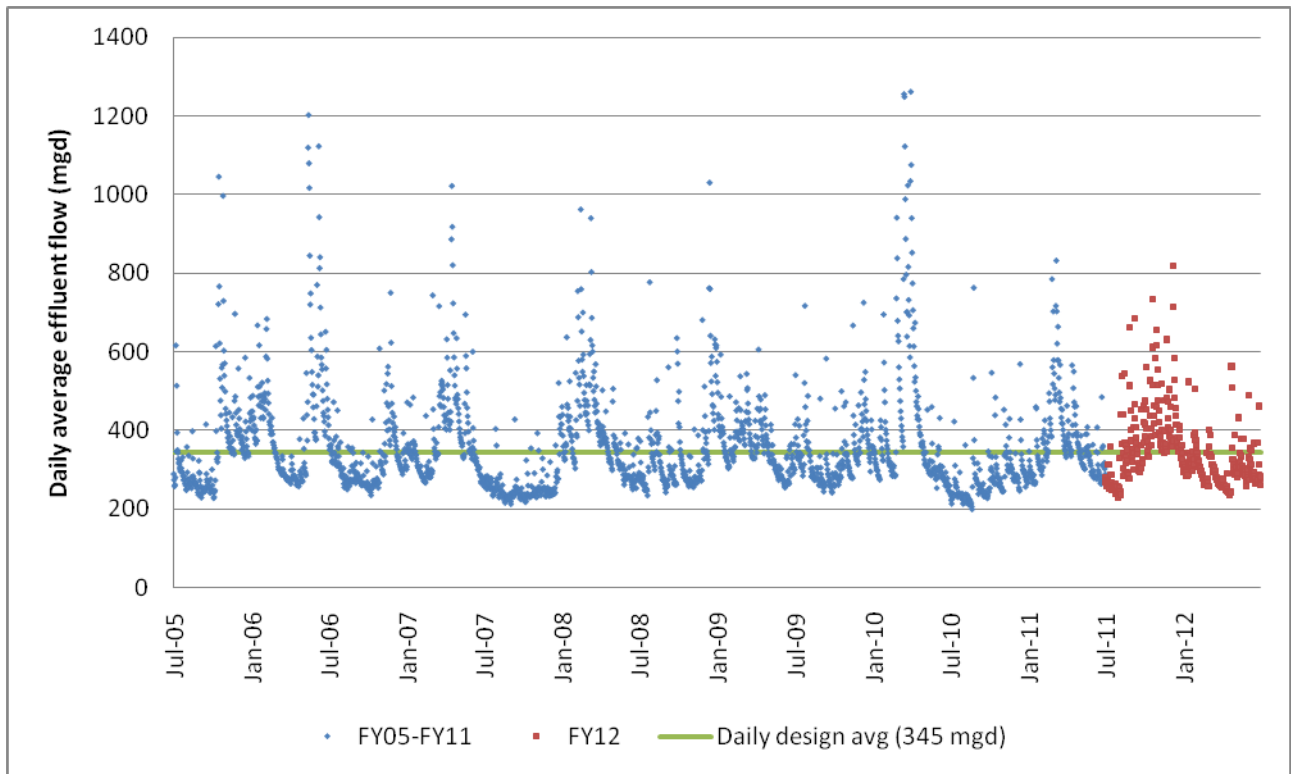

Figure 4. Daily average flow

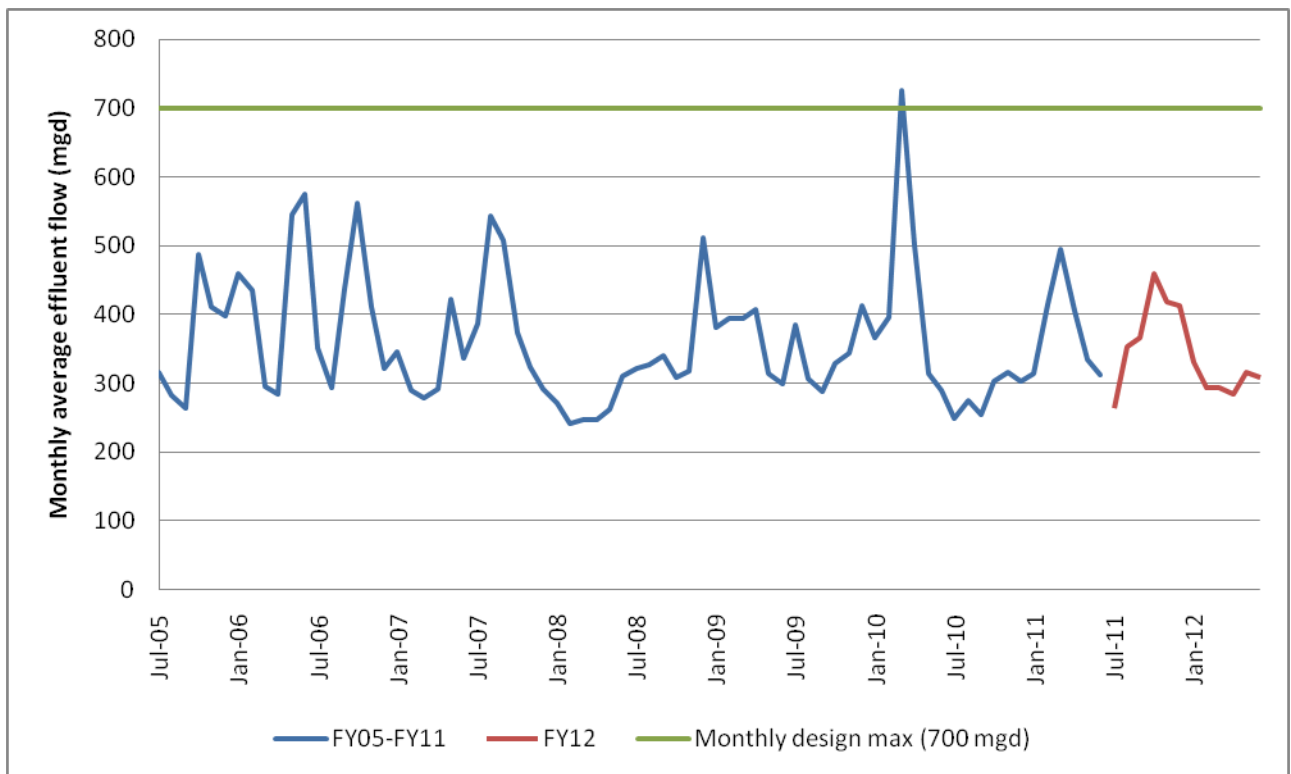

Figure 5. Monthly average flow

2.3.2 Nitrogen Loads

Extensive nitrogen data have been gathered from the nitrogen monitoring program. Whereas past reports used estimated nitrogen loads, actual data are now available to quantify nitrogen in the major waste streams at Deer Island.

Monitored nitrogen species include ammonia-nitrogen (NH_3^-), nitrites (NO_2^-), nitrate (NO_3^-), and total Kjeldahl nitrogen (TKN), all expressed as nitrogen. Total nitrogen (TN) is the sum of TKN, NO_3^- , and NO_2^- . For each monitoring event, the actual flow for each waste stream is used to derive the daily loads of each nitrogen species. The TN load is determined from these calculated loads.

The flow-weighted Deer Island raw wastewater concentration of ammonia was 27 mg/L and TN is 36 mg/L. These concentrations are typical of medium-strength wastewater.¹⁵ The average TN load during the same period from raw influent was about 102,700 lbs/d.

Return flows from residual processing in the original design of the plant were piped back to the primary clarifier. These flows include the gravity thickener overflow, the waste activated sludge centrate, and the digested sludge. In July 2003, the gravity thickener overflow was also piped to the south system pump station and the flow can either be pumped to the primary tanks or to the south system pump station, depending on pump availability. As of April 1, 2005, digested sludge is no longer thickened at Deer Island but is instead sent to the Residuals Pelletizing Plant in Quincy via the inter-island tunnel. Data analyzed for this report is for the period July 2005 to June 2012 and reflects the current plant operation.

Figure 6 shows TN mass balance across the unit processes at Deer Island. TN results from the monitoring program are very similar to TN results obtained from the theoretical calculated TN. Figure 7 shows the monthly average total nitrogen loads to the primary clarifiers, while Figure 8 shows the total nitrogen effluent loads out of the primary clarifiers, secondary clarifiers, and final effluent.

¹⁵ Metcalf & Eddy, Inc., *Wastewater Engineering: Treatment, Disposal and Reuse*, 3rd ed., 1991. p. 109.

Table 2. Summary of Nitrogen Monitoring Results

Sampling Location	Flow* (mgd)	TKN		NH3-N		NO3-N		NO2-N		NO3/NO2		Total Nitrogen	
		(mg/L)	(lb/d)	(mg/L)	(lb/d)	(mg/L)	(lb/d)	(mg/L)	(lb/d)	(mg/L)	(lb/d)	(mg/L)	(lb/d)
North System Influent (7/1/05 - 6/30/12)													
Minimum	140.5	7.1	32963	3.6	21498	0.00	0	0.00	0	~	~	8	32963
Maximum	887.7	51.0	156732	41.3	107271	2.04	10467	4.45	15016	~	~	51	159174
Average	235.4	27.6	51608	18.9	34799	0.21	531	0.22	468	~	~	28	52606
Standard Deviation	82.9	6.8	10309	5.5	6804	0.35	1195	0.33	937	~	~	7	10512
South System Influent (7/1/05 - 6/30/12)													
Minimum	60.3	8.5	20398	5.8	10600	0.00	0	0.00	0	~	~	10	20398
Maximum	389.6	120.0	144455	72.4	115825	2.27	6703	1.33	1893	~	~	120	145134
Average	123.5	53.2	50131	42.6	40003	0.11	200	0.14	161	~	~	53	50492
Standard Deviation	48.4	15.8	11355	13.2	8864	0.32	735	0.28	324	~	~	16	11391
Calculated Raw Influent													
Minimum	200.7	9.3	68742	5.9	45310	0.00	0	0.00	0	~	~	11	69347
Maximum	1261.7	62.1	207790	46.5	146093	2.09	17170	2.53	15397	~	~	62	214008
Average	358.9	35.8	101378	26.7	74880	0.17	717	0.17	583	~	~	36	102677
Standard Deviation	126.1	8.9	16761	7.4	11626	0.31	1916	0.23	1069	~	~	9	17289
Waste Activated Sludge (7/1/05 - 6/30/12)													
Minimum	0.00	21.7	419	4.7	41.2	~	~	~	~	0.00	0.00	21.7	419.3
Maximum	8.0	669.0	32472	45.6	2169.8	~	~	~	~	0.16	7.22	669.0	32472.9
Average	5.1	120.4	5210	26.9	1179.2	~	~	~	~	0.03	1.06	120.4	5211.4
Standard Deviation	1.1	54.0	2870	7.5	453.5	~	~	~	~	0.03	1.03	54.0	2870.0
Calculated Primary Influent													
Minimum	206.4	9.3	74577	5.9	45425	~	~	~	~	0.00	0	11.0	76277
Maximum	1261.7	64.8	209550	46.0	146431	~	~	~	~	2.91	20295	64.8	215769
Average	364.4	37.4	107048	26.8	75993	~	~	~	~	0.37	1360	37.8	108409
Standard Deviation	125.8	9.3	16347	7.2	11321	~	~	~	~	0.44	2396	9.1	16766
Primary Effluent (7/1/05 - 6/30/12)													
Minimum	200.7	9.2	48772	6.3	42520	~	~	~	~	0.00	0	11	49455
Maximum	1261.7	71.0	164296	45.1	129082	~	~	~	~	3.05	21197	71	164319
Average	362.9	33.7	95298	27.2	76473	~	~	~	~	0.26	1095	34	96392
Standard Deviation	129.1	9.2	15032	7.8	12797	~	~	~	~	0.45	2654	9	15088
Secondary Effluent (7/1/05 - 6/30/12)													
Minimum	200.7	7.6	35324	6.3	36897	~	~	~	~	0.03	60	9.6	41076
Maximum	700.7	46.6	120518	37.8	109456	~	~	~	~	4.04	19441	48.4	126086
Average	351.5	24.8	69415	23.8	66230	~	~	~	~	1.91	5582	26.7	74996
Standard Deviation	100.8	6.4	12830	6.4	10909	~	~	~	~	0.55	2178	6.5	13225
Final Effluent (7/1/05 - 6/30/12)													
Minimum	200.7	5.8	22489	4.6	18927	0.0	12.3	0.0	0.0	0.02	47	8.0	28358
Maximum	1261.7	38.1	150587	37.9	135835	4.9	29111	3.2	17946	4.76	33902	39.1	157720
Average	360.2	22.4	63105	21.6	60393	1.3	4132	0.9	2856	1.97	6217	24.5	69708
Standard Deviation	130.9	7.0	16388	7.2	15809	0.9	3539	0.6	2455	0.97	4378	6.7	16837

Notes:

* Flows reported are averages of the whole sampling period. The flow-weighted concentrations were calculated using flows during sampling events.

~ Average loads are calculated using all the data points.

~ No samples collected.

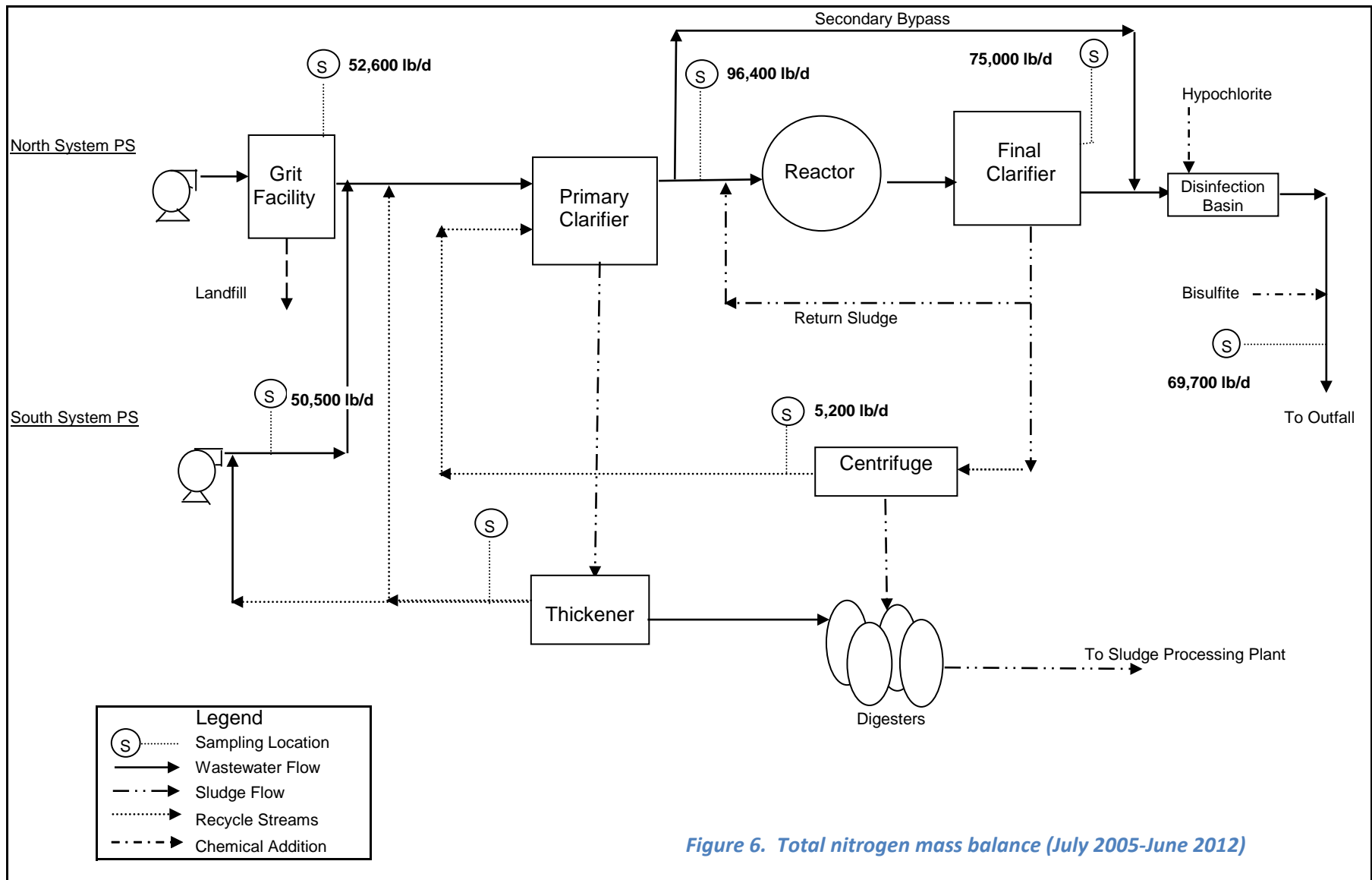

Figure 6. Total nitrogen mass balance (July 2005-June 2012)

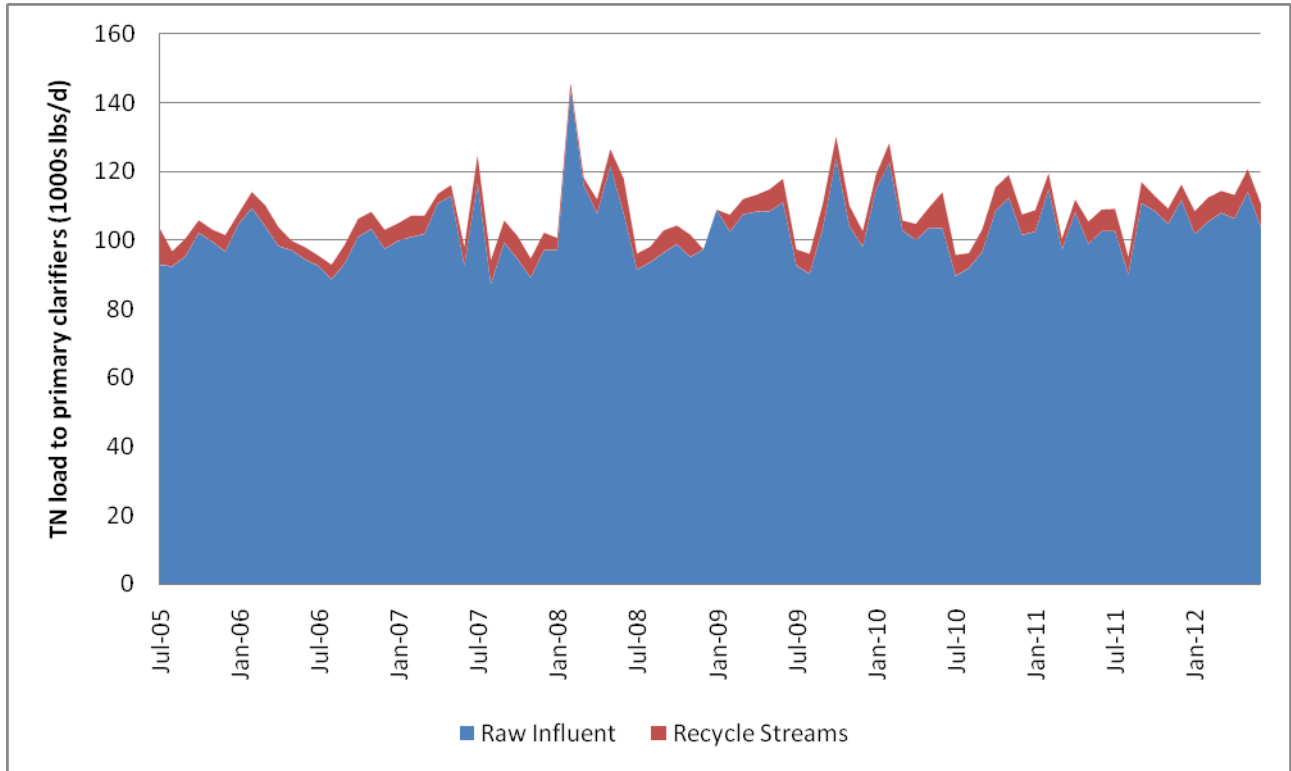

Figure 7. Total nitrogen load to primary clarifiers

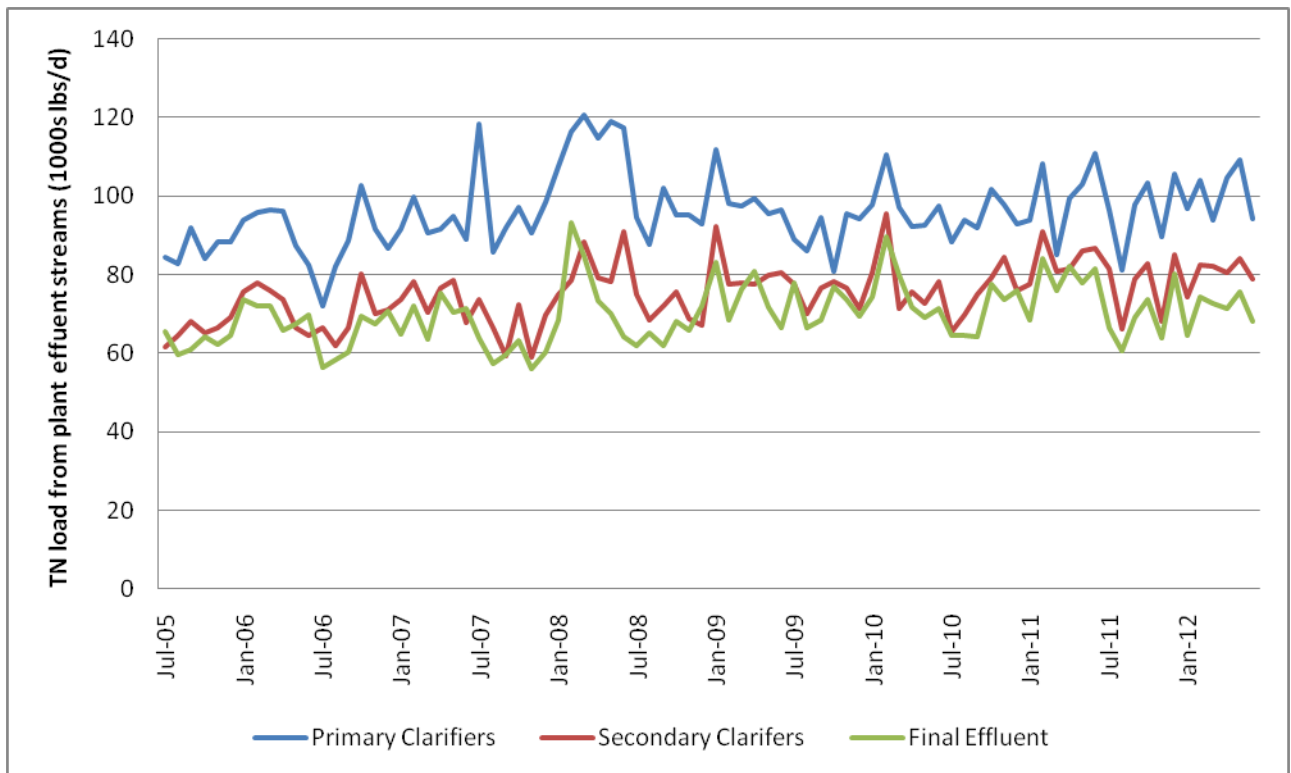

Figure 8. Total nitrogen load from plant effluent streams

2.4 Basic Design Information

To develop a conceptual design for a nitrogen removal system, some basic information is required. This includes ambient temperature, design flows and loads, and the target effluent quality.

2.4.1 Wastewater Temperature

Wastewater temperature is important for sizing biological systems for nitrification. As in most biochemical reactions, temperature greatly influences nitrification rates. The rate of ammonium oxidation depends on the growth rate of the bacteria *Nitrosomonas*, which in turn depends on temperature. Based on monitoring data and the possible requirement for year-round nitrification, the report uses the consultant's recommendation of a minimum wastewater temperature of 11°C (51.8°F).¹⁶ In FY12, the ambient wastewater temperature measurements of the south system influent averaged about 1.1°F lower than the north system influent.

Final effluent is probably the best source for determining the ambient temperature in designing a biological nitrogen removal system. The temperatures during FY12 were above the 51.8°F design criterion, the lowest recorded was 56.1°F. Plant performance would deteriorate during very cold weather but the lessened performance should not cause the plant to exceed its NPDES permit.

Figures 9 and 10 graph the north and south system influent temperatures, respectively, while Figure 11 depicts effluent temperatures during the monitoring period.

2.4.2 Design Flows and Nitrogen Loads

As a result of operational experiments conducted from March 2006 to June 2007, Deer Island established that it has a maximum-day capacity of 700 mgd for secondary treatment. As a result of the experiments, Deer Island set its process limit at 700 mgd. The revised estimate of plant flow capacity does not affect sizing of units for biological nitrogen treatment, because their design is based on organic and nitrogen loads, rather than on flow, and loads at Deer Island are largely independent of flow.

The design average plant flow of 361 mgd and the maximum sustainable flow to secondary of 700 mgd were used in the conceptual design of the nitrogen removal facility. The corresponding loads primary and in secondary effluent are presented in Table 3. Table 3 also compares previous load estimates with more current data. As shown, the estimates used in previous reports compare well with actual data.

¹⁶ Camp Dresser and McKee, *Technical Survey of Nitrogen Removal Technologies for the Deer Island Treatment Plant*, July 2001.

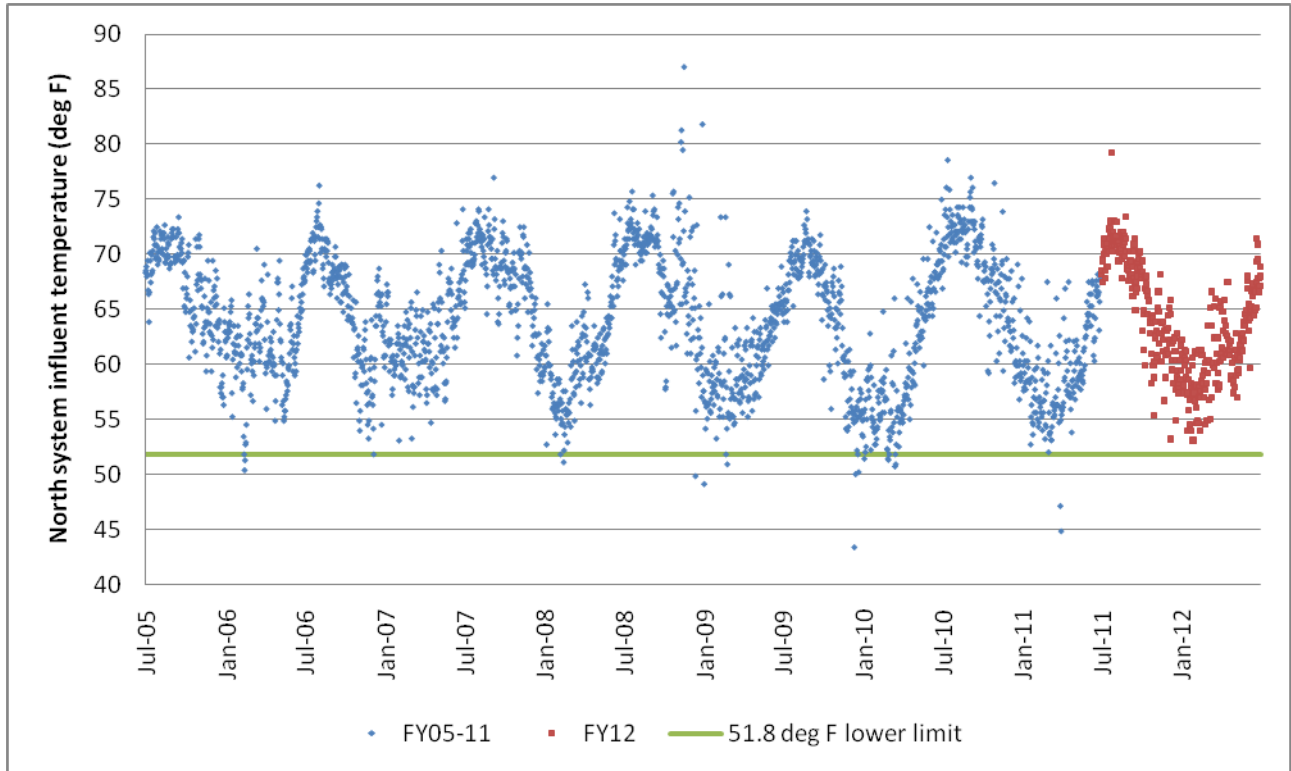

Figure 9. North System influent temperatures

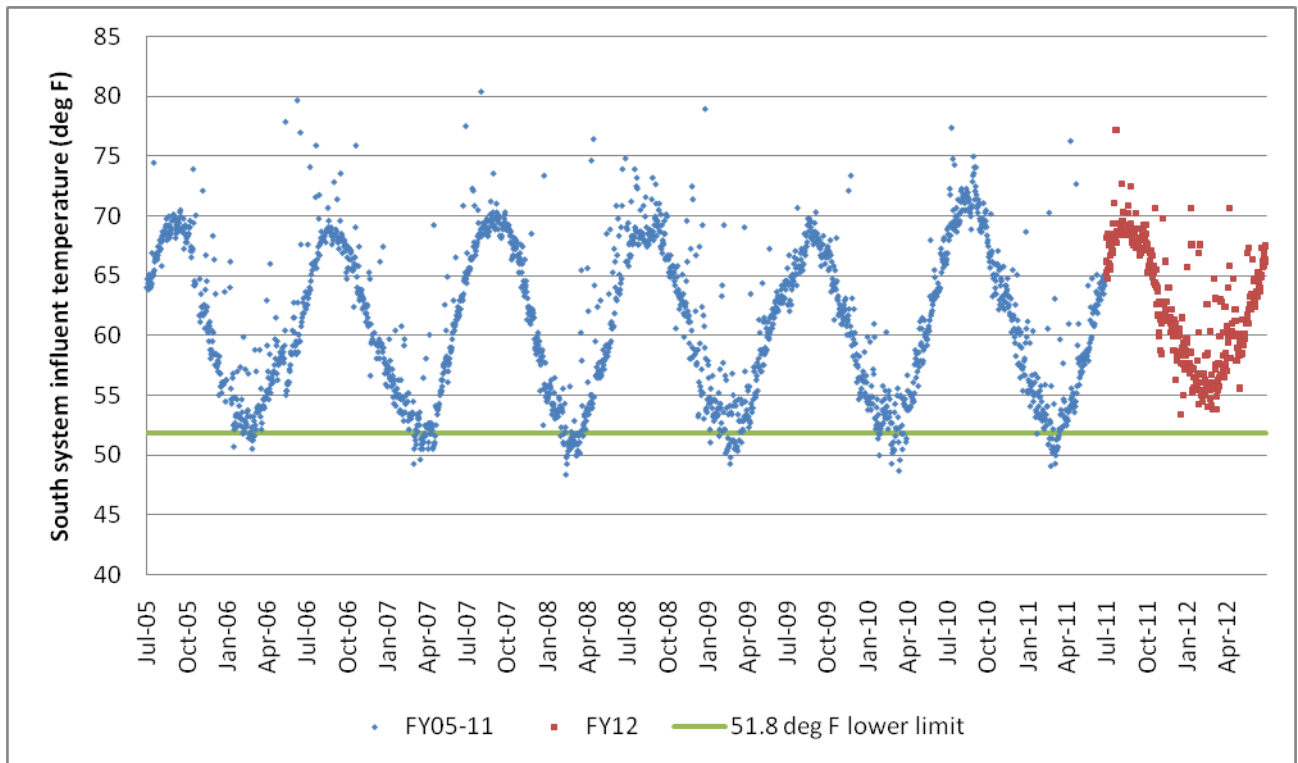

Figure 10. South System influent temperatures

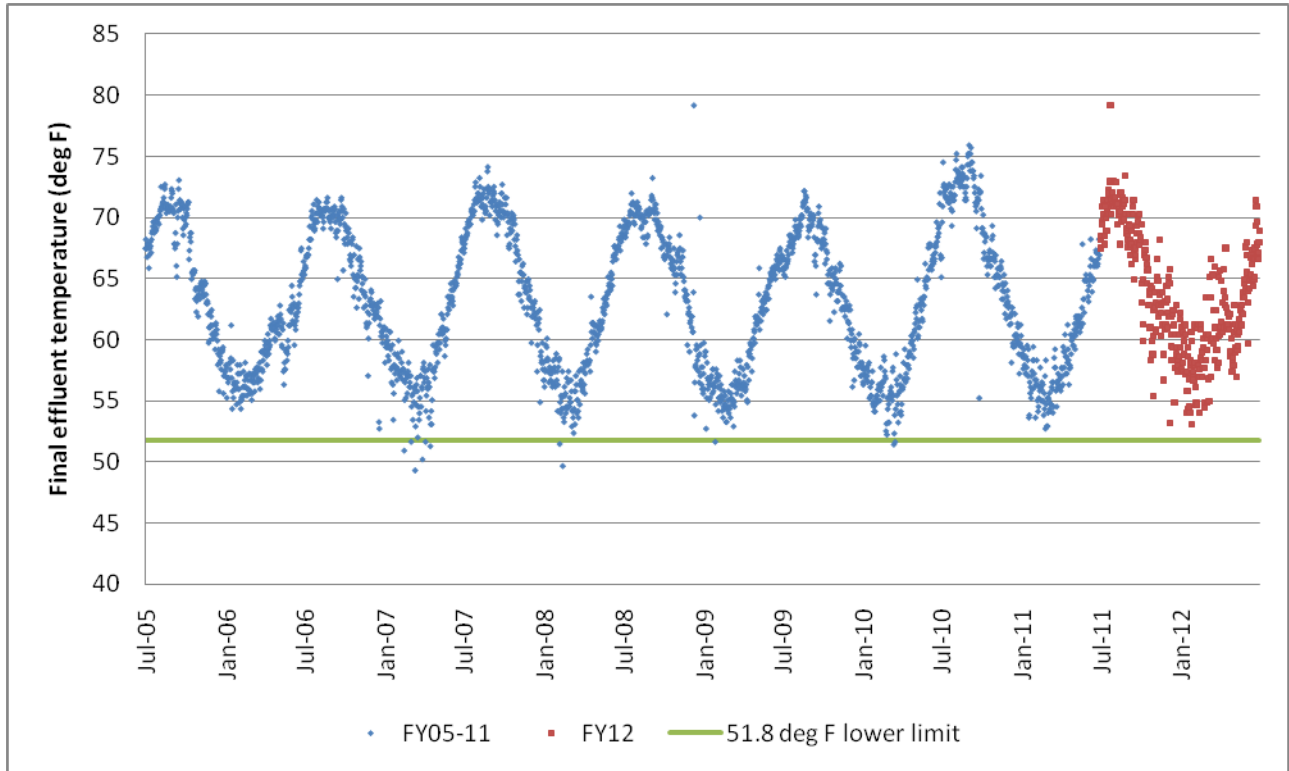

Figure 11. Final effluent temperatures

Table 3. Flows and nitrogen loads

	Flow (mgd)	Primary Effluent Nitrogen Load (lb/d)		Secondary Effluent Nitrogen Load (lb/d)	
		2001*	FY06-FY12	2001*	FY06-FY12
Average – Day	361	80,600	96,400	66,200	75,000
Max – Month	700	104,700†	120,475	86,000†	95,500

* Based on limited monitoring data (July-December 1999) and estimated total nitrogen loads from residuals processing recycle flows.

† Estimated.

2.4.3 Required Effluent Quality

Limits for nitrogen in effluent from Deer Island have not been set. This evaluation considers two levels of effluent quality: 4 mg/L and 8 mg/L of total nitrogen, both year-round. These concentrations reflect typical effluent standards for nitrogen. Conceptual land requirements and site layouts are conservatively based on the lower effluent limit because it requires more space for nitrogen removal.

Section 3. Screening of Alternatives

This section identifies processes available to remove nitrogen from wastewater and screens them to generate a list of alternatives appropriate for further evaluation. Table 3-1 summarizes the alternatives, and Section 4 examines them in detail.

Nitrogen removal technologies fall into three basic camps: physical/chemical processes, biological processes, and hybrids of the two.

3.1 Physical/Chemical Processes

Physical/chemical processes rely on basic chemical reactions to remove nitrogen species.

Physical/chemical processes employed for nitrogen removal include reverse osmosis, ammonia stripping, ion exchange, and breakpoint chlorination.

Reverse osmosis is expensive and requires a high degree of pretreatment; its use is not necessary to achieve potential nitrogen standards at Deer Island.

Ammonia stripping requires addition of lime to raise the pH of wastewater to about 11. At this pH, ammonia is present as a gas, rather than as the ammonium ion. The limed wastewater is sprayed over a packing material, with air added counter current to the liquid flow to strip the ammonia gas. A problem with this alternative is that power requirements and ammonia emissions are high, and the calcium carbonate scale that forms on the packing requires a high level of maintenance.

In ion exchange, wastewater is passed through a bed of material that exchanges sodium or potassium in the exchange material for the ammonium ion in wastewater. When the ion-exchange material becomes exhausted, passing a caustic solution through the bed regenerates it. Regeneration releases the adsorbed ammonium ions, which are collected in the exhaust solution. Ammonia in the exhaust can be recovered for use as a fertilizer. A problem with ion exchange is high operation and maintenance costs and headloss resulting from suspended solids build-up on the resin.

With breakpoint chlorination, chlorine at high doses oxidizes ammonia nitrogen to nitrogen gas. Dechlorination is needed after breakpoint chlorination, and volatile organic compounds such as chloroform and other trihalomethanes are formed. Breakpoint chlorination must be preceded by treatment beyond secondary treatment, typically coagulation, settling, and filtration, thus making it most effective on polished effluents. A problem with this alternative is that the chlorine demand will be too great to allow for cost-effective implementation.

Physical/chemical processes remove nitrogen only in the ammonia form. They do not remove organic nitrogen or nitrite and nitrate. They have never been used extensively, and their use is declining, so there are few plants now using physical/chemical processes for nitrogen removal. Physical/chemical processes are judged to be inappropriate for use at Deer Island.

3.2 Biological Processes

Biological nitrogen removal involves two processes in sequence: nitrification in an aerobic environment and denitrification in the absence of oxygen. In nitrification, ammonia is oxidized to nitrite and then to nitrate. In denitrification, nitrate is reduced to nitrogen gas. For denitrification to occur at an appreciable rate, suitable concentrations of organic material must be present. In some configurations, the organic matter present in the wastewater is sufficient for denitrification to occur. For other configurations, a supplementary source, such as methanol, must be provided.

Processes available for biological nitrification and denitrification include suspended-growth systems, fixed-film systems, and hybrid systems. In hybrid systems, fixed-film material is added to the aeration tank of suspended-growth systems.

3.2.1 Suspended Growth Systems

Deer Island uses the activated-sludge process to provide secondary treatment. The activated sludge units at Deer Island include aeration tanks and secondary clarifiers. Options for use of the activated sludge process for nitrogen removal at Deer Island include:

- Sequencing batch reactors
- Membrane activated sludge systems
- Two-stage activated sludge
- Single-stage activated sludge

Sequencing Batch Reactors

Sequencing batch reactors combine biological activity and settling in a single tank, rather than separating these functions in an aeration tank and a clarifier. They do not save space, however, and control and piping become complicated for large facilities. They are not evaluated further in this report.

Membrane Activated Sludge Systems

Membrane activated sludge systems use membranes to separate effluent from biomass, instead of clarifiers. Their advantage is that the concentration of mixed liquor in aeration tanks can be much higher than with conventional activated sludge. With higher concentrations, the volume of aeration tanks can be decreased. Membrane activated sludge systems have not been used at plants larger than about one mgd, however. Membrane activated sludge systems are not further evaluated in this report.

Two-Stage Activated Sludge

When activated sludge systems were first used for nitrification, they were designed and built as two-stage systems, with the first stage designed to remove biochemical oxygen demand and the second stage designed to oxidize ammonia. It is now recognized that single-stage nitrification is feasible, and, except for special cases, today's treatment plants feature single-stage nitrification.

At Deer Island, two-stage nitrification would require construction of aeration tanks and clarifiers after the existing units. There is not enough space remaining to build these units, and two-stage nitrification is thus impractical.

Single-Stage Activated Sludge

Nitrification and denitrification can be obtained in a single-sludge system, such as the Modified Ludzack-Ettinger (MLE) process and step feed variation of the activated-sludge process. The MLE process modifies an aeration tank of an activated sludge system by incorporating an anoxic zone ahead of an aeration section designed to provide nitrification. Mixed liquor, which contains nitrate, is returned to the anoxic zone, and nitrate is reduced to nitrogen gas. The step-feed process can achieve denitrification by providing alternating anoxic and aerobic zones. This process has been used successfully in New York City.

To provide nitrification in cold weather (when the wastewater temperature can be 11°C or colder), the solids retention time (SRT) would have to be increased to about 11 days. Current design provides for an SRT of less than 3 days. So, more aeration tanks would be needed. An aeration volume equal to about seven of the existing three aeration batteries would be required. The area required (about ten acres) exceeds the space available with reasonable geometry and this option is dropped from further evaluation. Addition of an anoxic zone would require even more area. No additional clarifiers would need to be constructed, however, because flows would not increase.

3.2.2 Fixed Growth Systems

In fixed-film systems, the biological organisms grow on a supporting surface, in contrast to suspended-growth systems, where the organisms grow in a liquid phase and then have to be separated from effluent in clarifiers. Fixed film systems include rotating biological contactors, nitrifying trickling filters, biological aerated filters and submerged packed-bed reactors, fluidized bed reactors, and moving bed biofilm reactors.

Rotating Biological Contactors

Rotating biological contactors (RBCs) consist of disks rotating on shafts arranged so that all or part of the disks are submerged. Excessive growth sloughs from the disks and is captured in clarifiers. For aerobic treatment, the disks are submerged to about 40% of their diameter. For denitrification, the disks are completely submerged. Mechanical reliability of RBCs can be a problem and RBCs are not often used at large treatment plants. Therefore, RBCs will not be reviewed further in this report.

Trickling Filters

Trickling filters can be used for nitrification after BOD removal, sometimes without the need for settling tanks. A preliminary comparison of the area required for trickling filters and of space available at Deer Island showed that space is insufficient. Additional odor control may be required for trickling filters. Nitrifying trickling filters will not be reviewed further.

Submerged Packed-Bed Reactors

Submerged packed-bed reactors are similar in configuration to biological aerated filters. They are not provided with aeration, however, and methanol is usually added to the feed stream to provide a carbon source. Like biological aerated filters, submerged packed-bed reactors require backwashing to remove trapped solids and excess biological growth. In the 1997 report, submerged packed-bed reactors were

considered separately from deep-bed filters. Because of their common features, these two systems are treated as one in this report. As in the 1997 report, submerged packed beds are further evaluated.

Nitrification and denitrification can be achieved in a single packed-bed that combines the features of a biological aerated filter and of a submerged packed-bed reactor. In this type of reactor, the packed-bed is about three meters deep. The diffusers are set at about two meters beneath the surface, so that the lower section is not aerated and denitrification takes place in the lower section. Methanol is required with secondary effluent because secondary effluent does not contain enough carbon for denitrification to proceed sufficiently. This combined nitrification/denitrification process has not been attempted at large plants and is not retained for further evaluation.

Fluidized-Bed Reactors

Fluidized-bed reactors are tanks filled with 4 to 10 feet of sand or other medium to support the growth of biomass. Wastewater is fed from the bottom of the reactor at a velocity high enough to fluidize the bed. (This contrasts with biological aerated filters, where the bed is not fluidized during normal operation.) Excessive growth shears from the medium and is separated from treated effluent in an upper zone of the reactor. These units were evaluated in the 1997 report for nitrification and for denitrification. The system supplier now believes that other options are preferred for nitrification, and fluidized-bed reactors are not retained for further study for nitrification. Fluidized-bed reactors are retained, however, for denitrification.

Moving-Bed Biofilm Reactors

The moving-bed biofilm reactor (MBBR) process consists of a tank filled with small plastic elements. The hollow cylindrical elements are about 1 cm in all dimensions and have ridges on the exterior and a crosspiece on the inside. A clarifier is required to separate excess growth. With air addition, MBBR can be used for nitrification. With methanol addition, the process can be used for denitrification. This process is recommended for further evaluation.

Biological Aerated Filters

Biological aerated filters (BAFs) consist of fully submerged, stationary beds of medium about 3 or 4 mm in diameter. Flow through the system is usually upward (although there are some downflow systems), and air diffusers are placed at the bottom of the filter. Periodically, the filters are backwashed to remove accumulated solids. The backwash water requires treatment and is usually returned to the main wastewater flow after settling. BAFs were evaluated in the 1997 report, and are retained here for further evaluation.

3.2.3 Hybrid Systems

Hybrid systems are sometimes called integrated fixed-film activated sludge systems. The fixed-film material placed in the suspended-growth tanks includes ropes, sponges, trickling filter media, RBCs and the media used for MBBR. These materials could be placed in the existing aeration tanks and increase their capacity. Capacity is increased because biomass grows on the fixed-film material as well as in the suspended phase. The 1997 report noted that more experience would be needed before the option could be recommended. Since then, additional information has become available, but rates for

nitrification still need further research (Sen *et al* 2000).¹⁷ This report does not further evaluate hybrid systems, but they should be considered if MWRA decides to conduct pilot tests of alternative nitrification systems. Pilot testing could be used to determine appropriate design criteria.

3.2.4 Treatment Innovations

Recently, several new processes for nitrogen removal have been developed based on the partial nitrification of ammonium to nitrite combined with anaerobic ammonium oxidation. However, these new processes target the removal of nitrogen from wastewater containing significant quantities of ammonium, such as sludge. The previous nitrogen removal technologies are better suited for Deer Island, but the following technologies are included in this report for completeness.

Single Reactor System for High Ammonia Removal Over Nitrite

In the single reactor system for high ammonia removal over nitrite (SHARON), ammonium is oxidized in one reactor system under aerobic conditions to nitrite, which in turn is reduced to nitrogen gas under anoxic conditions using an external carbon source.

Anaerobic Ammonium Oxidation

In the Anaerobic Ammonium Oxidation (ANAMMOX) process, nitrite and ammonium are converted into nitrogen gas under anaerobic conditions without the need for an external carbon source.

SHARON-Anammox Process

The Anammox process provides an alternative to nitrification with no requirement for an external carbon source. When combined with the SHARON process, the total aeration costs are greatly reduced when compared to the conventional nitrogen removal by nitrification-denitrification.

Completely Autotrophic Nitrogen Removal Over Nitrite

The Completely Autotrophic Nitrogen Removal Over Nitrite (CANON) process involves the removal of nitrogen within one reactor under oxygen limited conditions. An alternative to the 2-reactor SHARON-Anammox process, the ammonium oxidizing organisms coexist with the organisms performing the anammox process. Nitrite oxidizers, performing the unwanted reaction to nitrate, are outcompeted on two fronts: competing for ammonium with anammox, and competing with oxygen with the aerobic ammonium oxidizers.

¹⁷ Sen, D., *et al.*, *Investigation of Hybrid Systems for Enhanced Nutrient Control*, Project 96-CTS-4, Water Environment Research Foundation, 2000.

Table 4. Alternatives for controlling nitrogen at the Deer Island Treatment Plant

	Total Nitrogen Removal	
Physical/Chemical Processes		
Ammonia Stripping		X
Ion Exchange		X
Breakpoint Chlorination		X
Reverse Osmosis		X
	Nitrification	Denitrification
Biological Processes		
Suspended Growth		
Sequencing Batch Reactors	X	X
Membrane Activated Sludge	X	X
Single Stage and Two Stage	X	X
Fixed Film		
Rotating Biological Contactor	X	X
Nitrifying Trickling Filter	X	
Biological Aerated Filters	X	
Fluidized-Bed Reactors		X
Submerged Packed-Bed Reactor		X
Moving-Bed Biological Reactor	X	X
Hybrid Systems		
Rope Media	X	X
Sponge Media	X	X
Trickling-Filter Media	X	X
Rotating Biological Contactor	X	X
MBBR Media	X	X

3.3 Systems Retained for Further Evaluation

Table 3-2 shows systems retained for further evaluation. These systems were chosen based on ability to handle the flows and nitrogen loads at Deer Island, as well as experience with cost, reliability, and ability to fit into the available land at the treatment plant.

Table 5. Systems for further evaluation

	Nitrification	Denitrification
Biological Aerated Filters	X	
Submerged Packed Bed Reactors		X
Fluidized-Bed Reactors		X
Moving Bed Biofilm Reactor	X	X

Section 4. Evaluation of Alternatives

This section investigates the alternatives proposed in Section 3 for further evaluation. They are grouped into these process alternatives:

- Biological aerated filters for nitrification with submerged packed-bed reactors for denitrification
- Biological aerated filters for nitrification with fluidized-bed reactors for denitrification
- Moving-bed biofilm reactors for nitrification and denitrification

Development of the alternatives includes selection of criteria for sizing units and preliminary sizing of components. Alternatives are developed to meet standards of 4 mg/L and 8 mg/L of effluent nitrogen, but are designed conservatively to meet effluent levels of 3 mg/L and 6 mg/L, respectively.

Based on information provided, MWRA's consultant was able to obtain information about proprietary equipment and processes from system suppliers. Recommendations from the suppliers were reviewed, and professional judgment and experience were applied to select design criteria. The units provided allow for standby, such as for backwashing or other maintenance and for repair.

Oxygen requirements, chemical requirements, and sludge production for each alternative would be about equal. Those needs are covered in Section 4.4.

4.1 Biological Aerated Filters and Submerged Packed-Bed Reactors

Design criteria for nitrification in biological aerated filters (BAFs) and denitrification in submerged packed-bed reactors (SPBRs) are shown on Table 4. Two major suppliers provided recommendations for the criteria: Infilco Degremont, Inc., and Kruger, Inc. On the table, the number of units needed to meet nitrogen loads is calculated, based on loading criteria and on unit dimensions.

The table shows that 96 BAFs and 28 SPBRs would be required. These include standby units. To fit on the space available, the units would have to be constructed on two levels. Each level would include half of the units, plus blowers and other ancillary facilities.

To reach the new facilities, secondary effluent, which now flows to an effluent channel south of the secondary clarifiers, would be diverted to a new effluent channel north of the clarifiers and to a new pumping station to lift flow to the new facilities. Effluent from the new facilities would enter a new tunnel discharging to the chlorine contact tanks.

Blowers would provide aeration. The air would be injected at the base of each biological aerated filter and flow upward, co-current with the wastewater flow.

The BAFs and SPBRs both need to be backwashed approximately every two days, using final effluent for backwashing. Backwash waste would be returned to the head of the secondary system or to the head of the plant. Backwash rate is about 25 gpm/ft², for about eight minutes. Air required for backwashing is approximately 5000 scfm/cell.

The gross area required for siting the BAF and SPBR system, including blowers, a pump station and galleries would be about 5.7 acres, the entire available space in the area of secondary Battery D. Figure 12 shows the proposed BAF and SPBR layout.

4.2 Biological Aerated Filters and Fluidized-Bed Reactors

The BAF design for this treatment combination would be identical to that described in Section 4.1. Table 5 summarizes sizing information for the fluidized bed reactors (FBRs) for denitrification. The FBR design is based on information provided by US Filter. The effluent from the fluidized beds would flow to the chlorine disinfection basin and then be discharged from the facility.

The area requirements for the BAF/FBR system would be approximately 7 acres. This area exceeds the space available in Battery D, but the proposed layout can be incorporated as shown in Figure 13.

4.3 Moving-Bed Biofilm Reactors

For this option, Kaldnes provided the design concept criteria. Media would be added to the existing aeration tanks, where nitrification would occur.

Table 6 summarizes design criteria for the MBBR nitrification system and Table 7 summarizes the MBBR denitrification system. Because the MBBRs would be treating primary effluent, the analysis for MBBRs accounted for nitrogen removed via assimilation into the biomass produced during BOD removal. In the proposed MBBR systems, polyethylene media would be added to the existing aeration tanks. The biomass for biological treatment would grow on the media, thus eliminating the need for recycling solids from the secondary clarifiers. Stainless steel sieves would be installed at the outlets of the aeration basins to retain the media.

Table 6. Biological Aerated Filter for nitrification and Submerged Packed-Bed Reactors for denitrification

	BAF Nitrification	SPBR Denitrification
TKN Load (lb/d) Maximum Month	90,700	90,700
Nitrogen Loading Rate Allowed (lb/d/1,000ft ³)	40	190
Hydraulic Loading Rate Allowed (gpm/ft ²)	4	15
Unit Dimensions		
Depth (ft)	12.1	9.5
Surface Area (ft ²)	1,940	1,940
Volume (ft ³)	23,500	18,430
Active Units	96	26
Units Provided	96	28

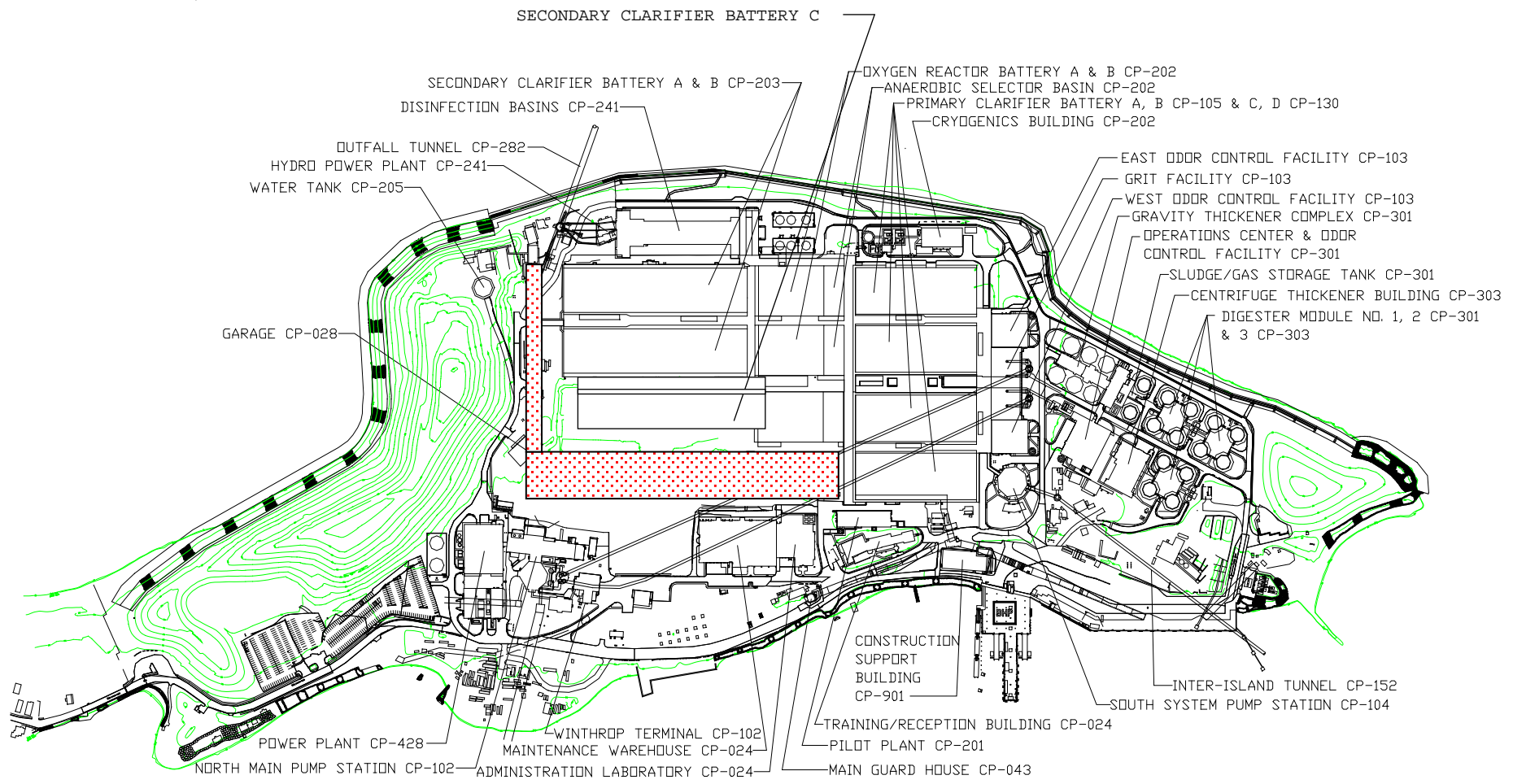
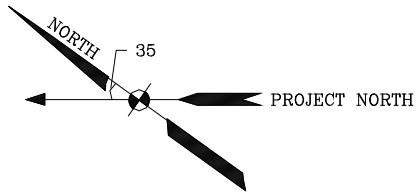

Figure 12. Proposed BAF and SPBR layout

Table 7. Biological Aerated Filter for nitrification and Fluidized Bed Reactors for denitrification

	BAF Nitrification	FBR Denitrification
TKN Load (lb/d) Maximum Month	90,700	90,700
Nitrogen Loading Rate Allowed (lb/d/1,000ft ³)	40	250
Hydraulic Loading Rate Allowed (gpm/ft ²)	4	18
Unit Dimensions		
Depth (ft)	12.1	10
Surface Area (ft ²)	1,940	800
Volume (ft ³)	23,500	8,000
Active Units	96	46
Units Provided	96	48

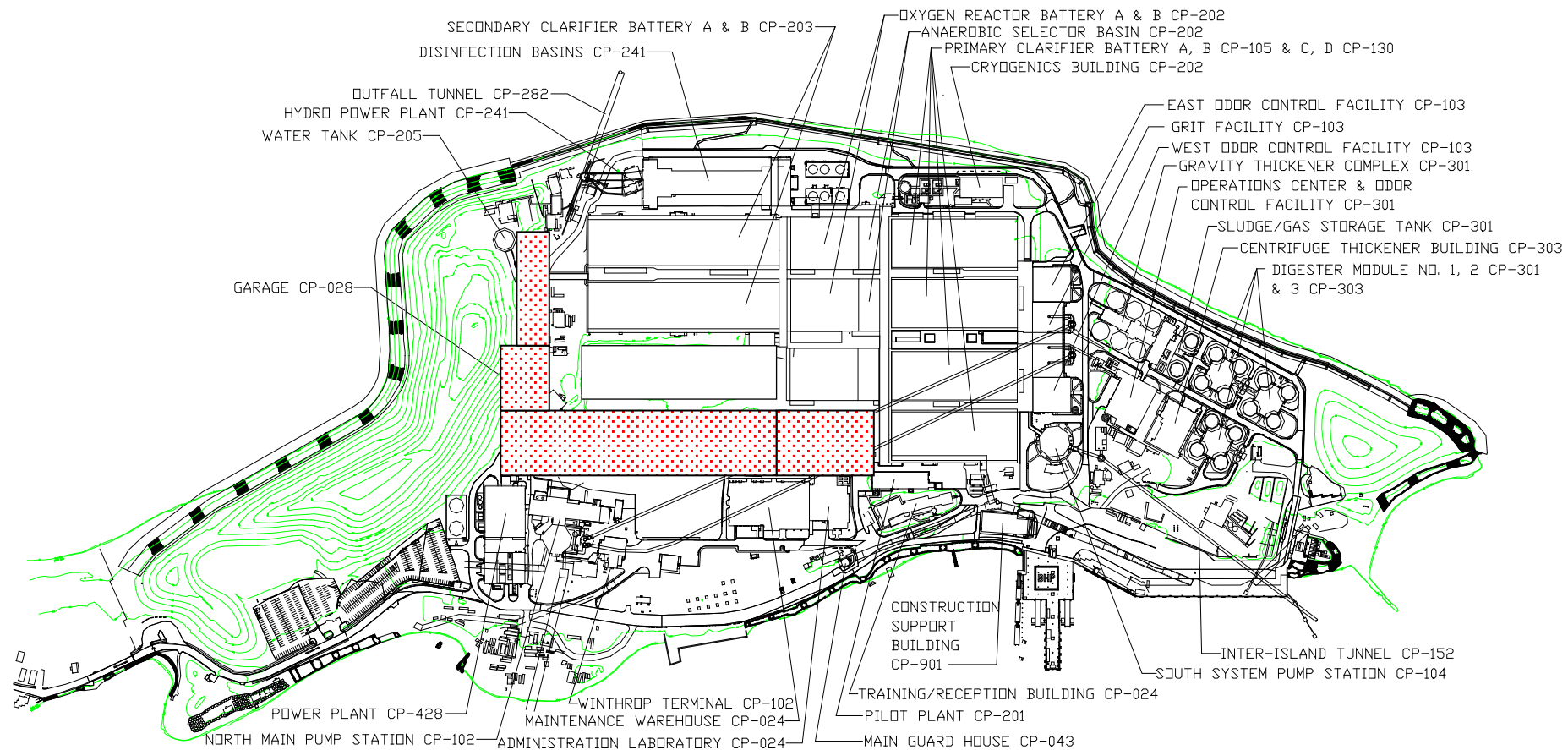
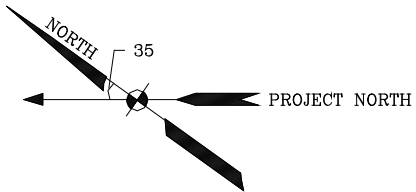

Figure 13. Proposed BAF and FBR layout

The existing on-site pure oxygen aeration system would provide oxygen and mixing. Because the aeration basins would now provide nitrification as well as oxidation of BOD, additional tankage, as described in Table 7, would be required to handle the design flows. Additional facilities for producing oxygen would also be required.

Effluent from the aeration basins would be deaerated before flowing to additional MBBRs for denitrification. Deaeration can be accomplished by nitrogen stripping, which drives dissolved oxygen from the wastewater. Nitrogen gas is a by-product of the cryogenic pure-oxygen generation system. This excess nitrogen can possibly be used as the nitrogen stripping source.

New effluent channels would be required to divert flow from the aeration basins to the denitrification MBBRs and then to the existing secondary settling basins for clarification.

For aeration, approximately 4,600,000 ft³ of new tanks would be required. The existing aeration basins provide 4,321,800 ft³. However, with the need to construct two new channels, 485,100 ft³ of aeration volume would be lost from the existing basins. The total new volume required (785,000 ft³) could be located in the space previously allotted for aeration Battery D.

Denitrification would require between 1,700,000 to 2,300,000 ft³ of new construction depending on the level of effluent nitrogen concentration to be met. Prior to denitrification, 152,000 ft³ of deaeration tankage is required to remove dissolved oxygen from the wastewater. Deaeration/denitrification facilities can also be sited in the space previously allocated for secondary clarifier Battery D. Methanol facilities for denitrification would be located between the vehicle maintenance building and the dry storage warehouse.

The proposed MBBR nitrification/denitrification system would require about 6.3 acres. Figure 14 shows the conceptual layout of the MBBR nitrification/ denitrification system.

Table 8. Moving Bed Biofilm Reactor for nitrification

	MBBR for Nitrification
Nitrogen Load in Primary Effluent (lb/d) Maximum Month	120,500
Nitrogen Assimilated Plus Ammonia Nitrogen in Effluent (lb/d)	19,000
Nitrogen Nitrified (lb/d)	101,600
Nitrification Rate (g/m ² ·d)	0.931
Specific Surface Area (m ² /m ³)	500
Total Media Required (ft ³)	3,500,000
% Fill of Carrier Elements	65%
Total Volume Required (ft ³)	5,400,000
Total Existing Aerobic Tank Volume (ft ³)	4,321,800
Volume Lost to New Channel (ft ³)	485,000
New Volume Provided (ft ³)	1,444,600
Unit Dimensions of New Basins	
Depth (ft)	24.5
Surface Area (ft ²)	4,900
Number of Basins	12

Table 9. Moving Bed Biofilm Reactor for denitrification

	MBBR for Denitrification	
	4 mg/L Total Nitrogen	8 mg/L Total Nitrogen
Total Nitrate Nitrogen Reduced (lb/d)	78,300	54,900
Loading Rate (g/m ² ·d)	2.45	2.45
Specific Surface Area (m ² /m ³)	500	500
Media Required (ft ³)	1,024,000	720,000
% Fill of Carrier Elements	40%	40%
Total Tank Volume (ft ³)	2,600,000	1,800,000
Deaeration Volume	152,000	152,000
Tank Dimensions		
Surface Area (ft ²)	4,900	4,900
Depth (ft)	24.5	24.5
Number of Reactors	22	15

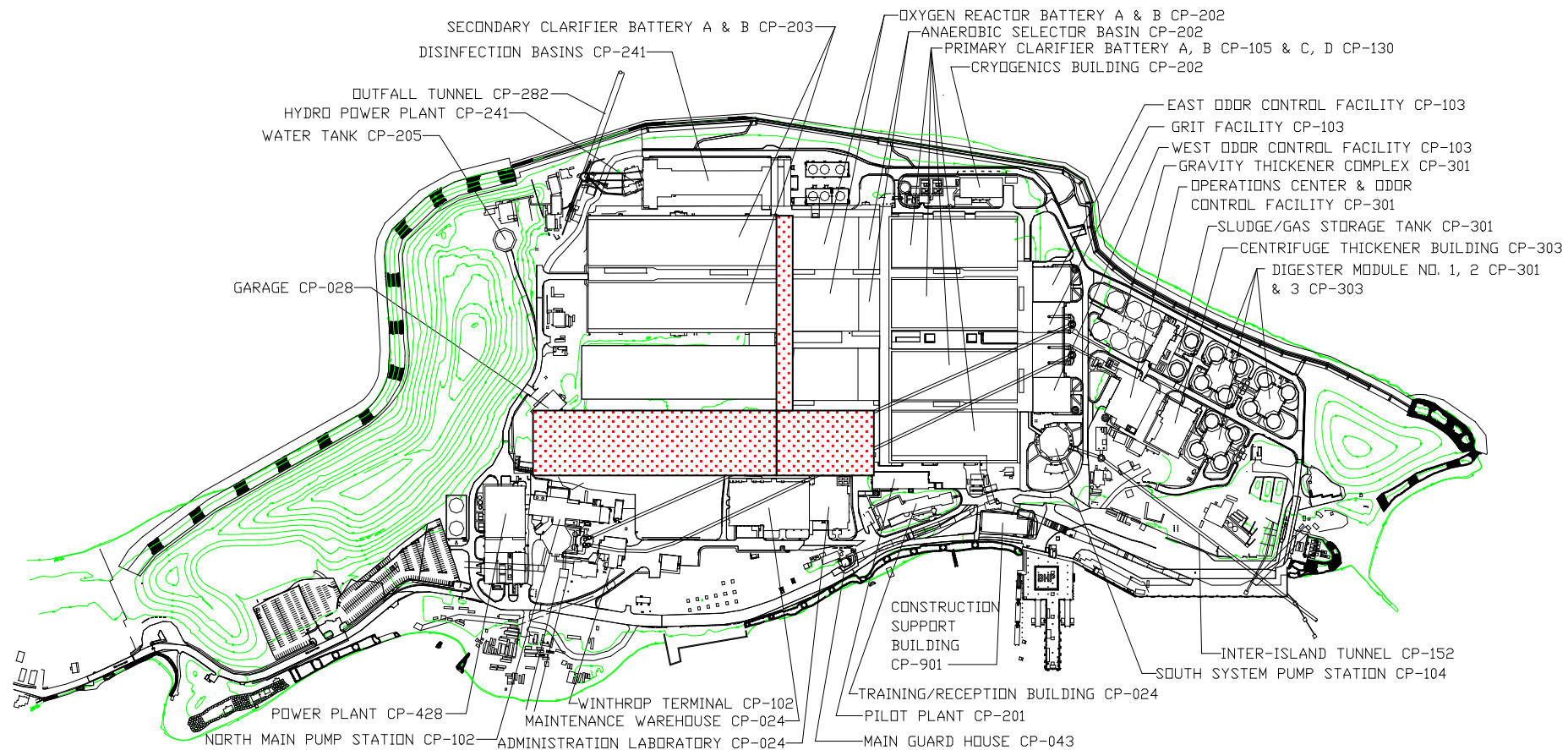
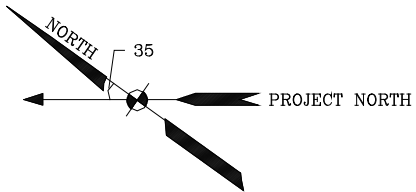

Figure 14. Proposed MBBR nitrification/denitrification layout

4.4 Common Elements

Elements common to the three alternatives include oxygen required for nitrification, chemical required for denitrification and additional capacity for processing sludge produced from both nitrification and denitrification systems.

4.4.1 Oxygen Requirement

Nitrification will increase the requirement for oxygen. This section examines two alternatives for providing oxygen.

The first case is for the BAF system, which would process secondary effluent from the existing activated-sludge system and for which air from the atmosphere would be used to provide oxygen. In that case, blowers provided by the system supplier would provide diffused air. The blowers would be housed in the BAF building. During the maximum day, about 280 tons/day of oxygen would be needed. Air use would be about 150,000 cfm at the maximum rate, and connected power for the blowers would be about 7,500 horsepower.

The second case is for the MBBR system, which would process primary effluent. With the MBBR system, high-purity oxygen would be used. Two new 150-ton units would have to be added, to supplement the two 150-ton/day units existing at Deer Island's cryogenic plant.

4.4.2 Chemical Requirements

Denitrification would require addition of methanol. The methanol requirement assumed for all of the denitrification systems is 3 lb methanol per lb of nitrate-nitrogen reduced. Methanol consumption for denitrification would average about 223,000 lb/d for less than 8 mg/L effluent TN concentration and 293,000 lb/d for an effluent TN concentration of less than 4 mg/L at maximum month flows. Two 243,000 gallon methanol storage tanks would be required. Each tank would provide about 14 days of storage.

4.4.3 Sludge Processing

Methanol addition would increase sludge production at the rate of about 0.6 lb/lb of nitrate nitrogen reduced. About 78,200 lbs/d of nitrogen would be reduced to achieve 4 mg/L of total nitrogen during the maximum month, and about 47,000 lb/d of additional sludge would thus be produced.

The additional sludge produced would impact thickening of biological sludge and sludge digestion. At a concentration of about 0.6%, additional sludge to be thickened would amount to about 640 gpm. The design concentration of thickened biological sludge is 5% and the digesters are sized to provide 15 days of storage at the maximum month. Under these conditions, about 2 million gallons of digestion capacity would be needed. Based on current operating practices, the digesters have enough capacity to handle the additional sludge flow.

4.5 Recommendations for Future Considerations

Biological nitrogen removal technologies appear to be the most cost-effective method of nitrogen removal at this time. In the spring of 2003, the Water Environment Research Foundation research

project *Sustainable Technology for Achieving Very Low Nitrogen and Phosphorus Effluent Levels*¹⁸ commenced. This 2-year project assessed a variety of technologies to develop information about the feasibility and cost benefits of nutrient reduction. MWRA is looking into the final report of the study for consideration at Deer Island. Additional considerations in the selection of alternative options include separate treatment of residual processing return flows at Fore River, decreasing methanol requirements, and utilizing the existing pilot plant to study nitrification rates.

4.5.1 Separate Treatment at the Residuals Processing Plant

Since April 2005, digested sludge has been sent to the Residuals Processing Plant in Quincy via the inter-island tunnel. With all processing of digested sludge taking place at the Processing Plant, sidestreams from thickening and dewatering digested sludge contain high concentrations of ammonia, and it might be economical to treat the sidestreams for nitrogen removal at the Processing Plant. Treatment at the Residuals Processing Plant therefore may decrease the size of facilities needed at Deer Island.

4.5.2 Side Stream Treatment at Deer Island Treatment Plant

The combined gravity thickener overflow and the waste activated sludge recycle streams is about 11.0 mgd and contains about 10,500 pounds of total nitrogen, about 10% of the total load to the plant. Pretreatment of these streams will reduce the load to the activated sludge process but it is not certain if the effluent nitrogen concentrations can meet water quality standards. This option will have to be further investigated.

4.5.3 Decreasing Requirement for Methanol

All the alternatives considered in Section 4 would require addition of methanol as a carbon source for denitrification. With these options, purchase of methanol would be a major expense. Applying treatment processes that use wastewater to provide the carbon source would decrease use of methanol.

Section 3.2.1 described the Modified Ludzack-Ettinger (MLE) process, which is a modification of the activated sludge process. In that section, it was stated that the MLE process and other modifications of the activated sludge process require more space than is available at Deer Island. The volume (and hence, space) required can be decreased by adding carrier material to the system, to serve as medium on which dense biological growth could be supported. The carrier material could be used to support a fixed film (as discussed in Section 3.2.2) or could be a hybrid system (as discussed in Section 3.2.3). Additional work would be required to assess the kinetics of these systems and to determine how to configure tanks and piping at Deer Island.

¹⁸ Water Environment Research Foundation, *Progress*, vol. 14(2), Spring 2003.



Massachusetts Water Resources Authority
Charlestown Navy Yard
100 First Avenue
Boston, MA 02129
(617) 242-6000