

# Technical Survey of Nitrogen Removal Alternatives for the Deer Island Treatment Plant

---

Massachusetts Water Resources Authority

Environmental Quality Department  
ENQUAD Report 2005-24



Bigornia-Vitale, G, Wu, D. 2005. **Technical Survey of Nitrogen Removal Alternatives for the Deer Island Treatment Plant.** Boston: Massachusetts Water Resources Authority. Report ENQUAD 2005-24. 44 p.

***Technical Survey of Nitrogen Removal Alternatives for  
the  
Deer Island Treatment Plant***

***Updated by:  
Grace Bigornia-Vitale  
David Wu***

Massachusetts Water Resources Authority  
Environmental Quality Department  
100 First Avenue  
Boston, MA 02129

December 2005  
Technical Report 2005-24

# Table of Contents

<b>Executive Summary .....</b>	<b>1</b>
<b>Section 1 – Introduction.....</b>	<b>3</b>
1.1 Purpose of Report .....	3
1.2 Content of Report .....	3
<b>Section 2 - Basic Planning Criteria .....</b>	<b>4</b>
2.1 Existing Facilities .....	4
2.2 Available Space .....	4
2.3 Flows and Loads.....	8
2.3.1 Flows .....	8
2.3.2 Nitrogen Loads .....	10
2.4 Basic Design Information .....	16
2.4.1 Wastewater Temperature .....	16
2.4.2 Design Flows and Loads.....	16
2.4.3 Desired Effluent Quality.....	18
<b>Section 3 – Screening of Alternatives.....</b>	<b>19</b>
3.1 Physical/Chemical Processes .....	19
3.2 Biological Processes.....	20
3.2.1 Suspended Growth Systems .....	20
3.2.2 Fixed Growth Systems.....	21
3.2.3 Hybrid Systems .....	23
3.3 Systems Retained for Further Evaluation .....	25
<b>Section 4 - Evaluation of Alternatives.....</b>	<b>26</b>
4.1 Biological Aerated Filters and Submerged Packed-Bed Reactors .....	26
4.2 Biological Aerated Filters and Fluidized-Bed Reactors.....	27
4.3 Moving-Bed Biofilm Reactors.....	27
4.4 Common Elements .....	36
4.4.1 Oxygen Requirement.....	36
4.4.2 Chemical Requirements.....	36
4.4.3 Sludge Processing.....	36
4.5 Recommendations for Future Consideration .....	37
4.5.1 Separate Treatment at Fore River.....	37
4.5.2 Decreasing Requirement for Methanol .....	37
4.5.3 Testing at Pilot Plant.....	38

# Tables

2-1	Facilities at Deer Island Treatment Plant .....	6
2-2	Summary of Nitrogen Monitoring Results .....	12
2-3	Flows and Nitrogen Loads .....	18
3-1	Alternatives for Controlling Nitrogen at the Deer Island Treatment Plant .....	24
3-2	Systems for Further Evaluation .....	25
4-1	Biological Aerated Filter for Nitrification and Submerged Packed-Bed Reactors for Denitrification .....	28
4-2	Biological Aerated Filter for Nitrification and Fluidized-Bed Reactors for Denitrification .....	30
4-3	Moving-Bed Biofilm Reactor for Nitrification .....	33
4-4	Moving-Bed Biofilm Reactor for Denitrification .....	34

# Figures

2-1	Deer Island Site Plan .....	5
2-2	Space Available for Nutrient Control .....	7
2-3	Deer Island Process Flow Diagram .....	9
2-4	Daily Average Flow .....	10
2-5	Monthly Average Flow .....	10
2-6	Total Nitrogen Mass Balance .....	14
2-7	Total Nitrogen Load to Primary Clarifiers.....	15
2-8	Load from Plant Effluent Streams .....	15
2-9	North System Influent Temperature.....	17
2-10	South System Influent Temperature .....	17
2-11	Final Effluent Temperature .....	18
4-1	Proposed Layout for BAF/SPBR Option .....	29
4-2	Proposed Layout for BAF/FBR Option.....	31
4-3	Proposed Layout for Nitrification/Denitrification MBBR Option .....	35

# Executive Summary

Section 8.e.i of MWRA's NPDES discharge permit (No. MA0103284) requires MWRA to "maintain a comprehensive technical survey of effective treatment technologies for nitrogen removal which are applicable to the Deer Island treatment facility." The purpose of the survey is to "facilitate the speedy selection and implementation of nitrogen removal technology if necessary."

The requirement for the survey grows out of concern about the possible impacts of nitrogen, a nutrient, on the Massachusetts Bay ecosystem. Worries that the additional nitrogen in effluent might lead to low dissolved oxygen or undesirable algal blooms in the Bay prompted the inclusion of the above clauses in the permit. Should MWRA need to cut down on nitrogen discharges, the survey will allow MWRA to quickly make an informed decision on available removal options.

This report updates reports submitted in November 2001<sup>1</sup>, June 2003<sup>2</sup>, February 2004<sup>3</sup> and October 2004.<sup>4</sup> The design criteria for the selection of alternative treatment remain unchanged and are based on their suitability at Deer Island, process reliability, and land and space requirements.

Approximately 13 acres of usable area exist for siting potential nitrogen removal facilities. This area would allow for the construction of nitrogen removal facilities without significantly encroaching on the landforms that were constructed to mitigate noise and visual impacts on the Town of Winthrop.

Results of nitrogen monitoring conducted for the period July 2001 to June 2005 support the assumptions and estimates used in the original evaluation of treatment options. All three alternatives presented in the earlier studies are still found to be viable options at the Deer Island site. These treatment alternatives are biological aerated filters with submerged packed-bed reactors, biological aerated filters with fluidized-bed reactors, and moving-bed biofilm reactors. The evaluation consisted of sizing and siting facilities based on available space and wastewater flows and loads at the Deer Island Treatment Plant.

---

<sup>1</sup> Camp Dresser and McKee, *Technical Survey of Nitrogen Removal Technologies for the Deer Island Treatment Plant*, July 2001.

<sup>2</sup> Massachusetts Water Resources Authority, *Technical Survey of Nitrogen Removal Technologies for the Deer Island Treatment Plant*, June 2003.

<sup>3</sup> Massachusetts Water Resources Authority, *Technical Survey of Nitrogen Removal Technologies for the Deer Island Treatment Plant*, February 2004.

<sup>4</sup> Massachusetts Water Resources Authority, *Technical Survey of Nitrogen Removal Technologies for the Deer Island Treatment Plant*, October 2004.

Biological nitrogen removal technologies appear to be the most cost-effective method of nitrogen removal at this time. A research project entitled *Sustainable Technology for Achieving Very Low Nitrogen and Phosphorus Effluent Levels*<sup>5</sup>, funded by the Water Environment Research Foundation, is underway. This 2-year effort will assess a variety of technologies to determine the feasibility and cost benefits of nutrient reduction to treatment plants around the nation. MWRA will continue to monitor the progress of this project as well as review emerging technologies for applicability to Deer Island.

---

<sup>5</sup> Water Environment Research Foundation, Progress, vol 14(2), Spring 2003.



# Section 1

## Introduction

### 1.1 Purpose of Report

MWRA's NPDES permit requires maintenance of a comprehensive technical survey of nitrogen removal technologies that are applicable to the Deer Island Treatment Plant. This report updates the previous report *Nitrogen Removal Alternatives for the Deer Island Wastewater Treatment Facilities* released in October 2004. This update will help to facilitate selection and implementation of nitrogen removal technology if such technology is required at Deer Island.

### 1.2 Content of Report

This report describes existing conditions at the Deer Island site, and identifies and evaluates various treatment alternatives capable of providing nitrogen removal at the Deer Island facility.

Section 2 begins with a description of existing facilities and of the remaining space available at Deer Island for siting nitrogen removal facilities. Section 2 also presents the most current nitrogen monitoring data available and updates estimates of flows and nitrogen loads used in the previously submitted reports.

Section 3 discusses processes available for nitrogen removal. This section summarizes physical/chemical nitrogen removal and biological nitrification and denitrification technologies. Processes are evaluated for applicability to the Deer Island site, and viable alternatives are selected for a more in-depth review.

Section 4 investigates the alternatives selected in Section 3 for further review. Each alternative is sized to determine feasibility of implementation. Elements common to all three options, such as oxygen and chemical needs and sludge production, are evaluated separately. Section 4 also lists other considerations that should be evaluated in the selection of treatment alternatives.

## Section 2

# Basic Planning Criteria

This section reviews existing facilities and identifies available space that could be used for Nitrogen removal facilities. In addition, this section summarizes July 2001 – June 2005 nitrogen monitoring, updates flows and nitrogen loads from the previous report, and presents basic information used for selecting facilities.

### 2.1 Existing Facilities

The Deer Island Treatment Plant (Deer Island) is a pure oxygen activated sludge process treatment plant with a design average flow of 540 mgd and hydraulic capacity of 1270 mgd. Figure 2-1 depicts the DITP site layout and Table 2-1 lists major facilities and pertinent information regarding those facilities.

### 2.2 Available Space

Nitrogen removal would require additional facilities for wastewater treatment and solids processing. The goal of this analysis is to site these facilities in areas previously allocated for treatment processes or support facilities that were not built, and to avoid construction on the landforms developed to lessen the impact of wastewater treatment facilities on Winthrop.

Areas available for nitrogen removal facilities are highlighted on Figure 2-2 and include:

- Area A: 5.7 acres, the space west of existing secondary Batteries
- Area B: 0.4 acres, the area to the north of the secondary clarifiers
- Area C: 3.2 acres, the area north of Batteries B, C, and D, and
- Area D: 3.5 acres, the area located north of the maintenance dry storage warehouse

While the total available gross area is 12.8 acres, piping and operational considerations limit the use of available space and each option with its particular design requirements needs more in-depth evaluation for its feasibility. Section 4 presents these conceptual design evaluations.

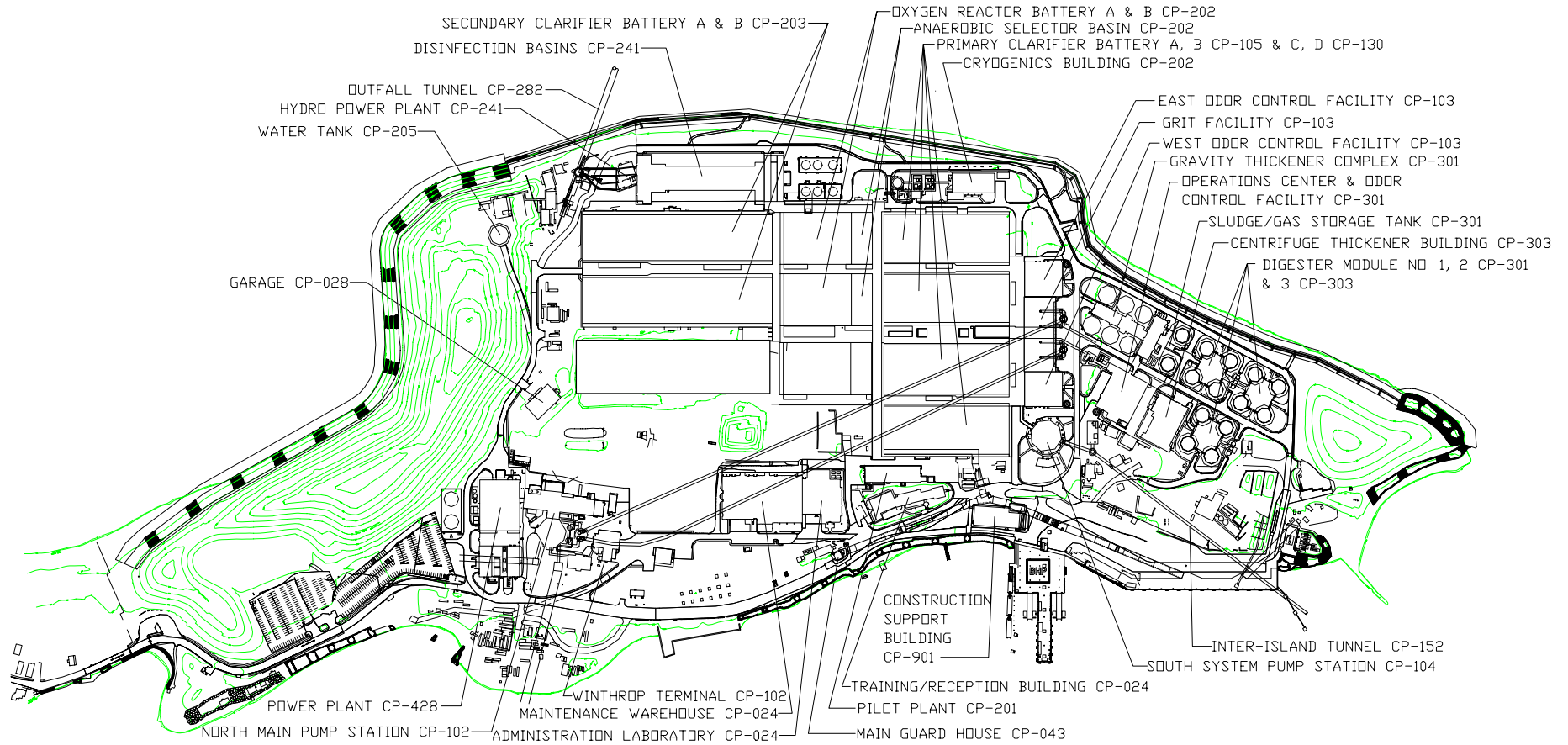
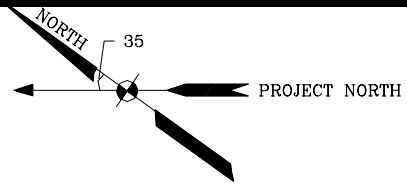

Figure 2-1  
Deer Island Site Plan

**Table 2-1  
Facilities at Deer Island Treatment Plant**

<b>Stacked Rectangular Primary Clarifiers</b>	
Number of batteries	4
Clarifiers per battery (stacked sets)	12
Effective surface area per clarifier (ft <sup>2</sup> )	15,252
<b>Aeration Tanks</b>	
Number of batteries	3
Number of trains per battery	3
Total number of trains	9
Number of stages for selectors	3/train
Volume of selectors per train (MG)	1.07
Number of aeration stages per train	4
Aeration volume per train (MG)	3.55
<b>Stacked Rectangular Secondary Clarifiers</b>	
Number of batteries	3
Clarifiers per battery (stacked sets)	18
Effective surface area per clarifier (ft <sup>2</sup> )	13,940
<b>Gravity Thickeners (for Primary Sludge)</b>	
Number of units	6
Diameter (ft)	70
Sidewater depth (ft)	12
<b>Centrifuges for Thickening Waste Activated Sludge</b>	
Number	12
Allowable range flow/centrifuge (gpm)	300 to 900
<b>Anaerobic Digesters/Thickened Sludge Storage</b>	
Number of digesters	12
Volume of each digester (MG)	3.0
Number of storage tanks	2
Diameter (ft)	90
Total depth (ft)	130
Volume each (MG)	3.0
<b>Centrifuges for Thickening Digested Sludge*</b>	
Number	4
Allowable range flow/centrifuge (gpm)	350 to 800

\*Available for other use after pumping to Fore River is implemented

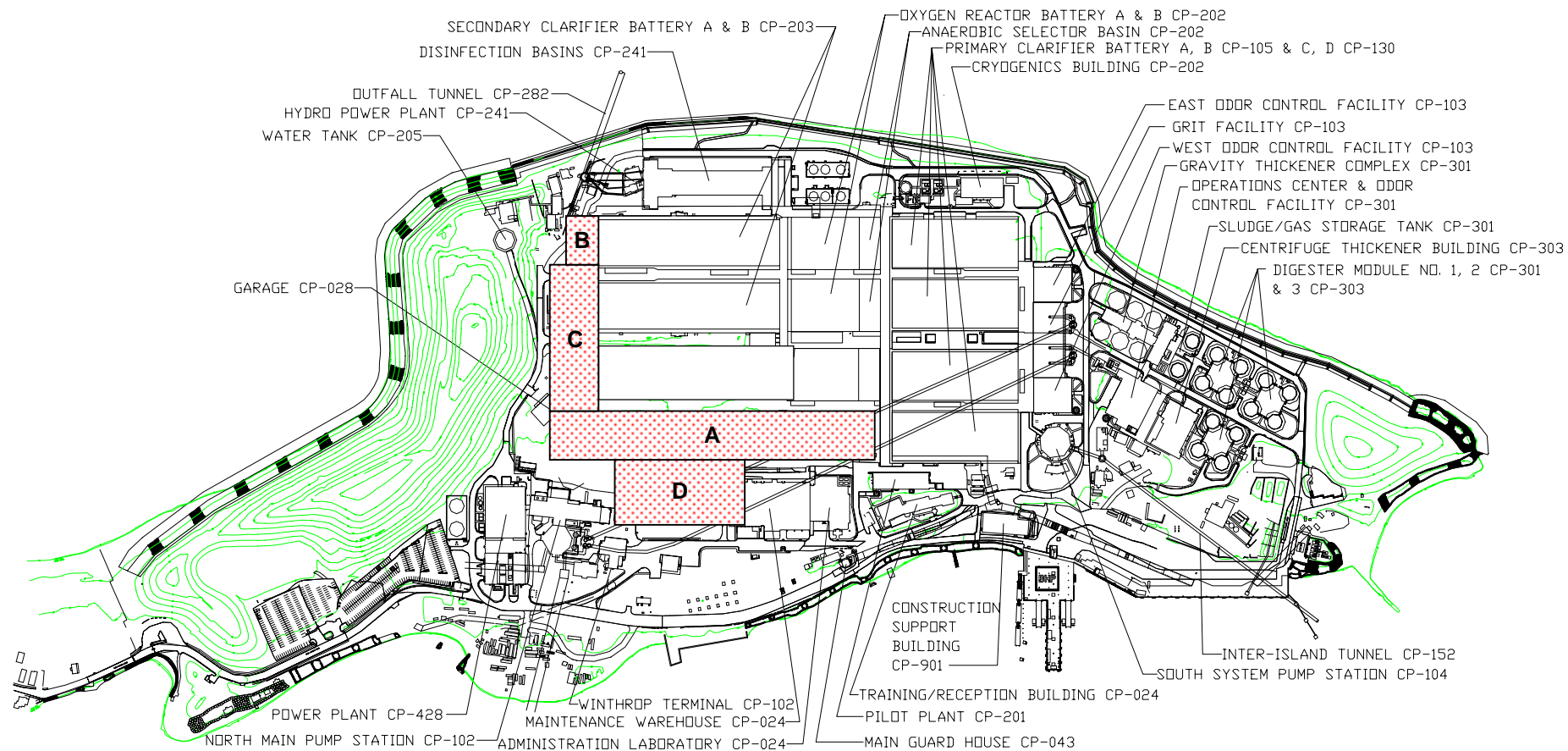
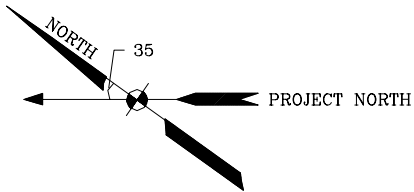

Figure 2-2  
Space Available for Nutrient Control

## 2.3 Flows and Loads

This section provides a summary of monitoring results conducted during the period July 2001 to June 2005 and quantifies nitrogen loads from the various wastewater streams. These new load calculations update the estimates that were used in developing and sizing the conceptual designs of the selected nitrogen removal alternatives in the July 2001 report.

In addition to the required NPDES permit influent and effluent monitoring, MWRA implemented a comprehensive nitrogen monitoring program.<sup>1</sup> The program aims to characterize wastewater streams within the treatment plant. Data will facilitate the selection, and if necessary, the design of nitrogen removal facilities at Deer Island.

Figure 2-3 shows the Deer Island process flow diagram and the various sampling locations along the process. South system flow arrives at the Deer Island's south system pump station via the inter-island tunnel and combines with the north system flow after the grit removal facility. This combined flow of raw wastewater is characterized by taking the flow-weighted average of the individual north and south system measurements.

### 2.3.1 Flows

The average daily flow from the combined north and the south system for the period July 2001 to June 2005 was 360 mgd. The highest monthly average flow, which occurred in April 2004, was 583 mgd. These two averages will be evaluated and compared to conceptual design flows of 345 and 540 mgd (average daily and maximum monthly design flows, respectively) that were established in design configurations in the earlier report. Figure 2-4 shows the daily effluent flow while Figure 2-5 graphs the monthly averages.

Previously, return streams from sludge processing at Deer Island were pumped back to the head of the primary clarifier. These waste streams include overflow from the gravity thickeners, centrate from waste sludge centrifuges, and centrate from the digested sludge centrifuges. In early 2003, the overflow from the thickener has been rerouted to the south system pump station, and since April 1, 2005, digested sludge centrate has been sent to the Sludge Pelletizing Plant in Quincy via the inter-island tunnel. Thus, the only return stream from residual processing that is pumped back to the head of the primary clarifier is the waste sludge centrate. The waste sludge centrate and gravity thickener overflow average about 4.69 and 5.29 mgd, respectively. While these flows can be considered negligible when compared to the raw influent, their nitrogen loads are high.

---

<sup>1</sup> Coughlin, Kelly, *Combined Work/Quality Assurance Project Plan for Nitrogen Monitoring in Deer Island Treatment Plant Waste Streams*, ENQUAD report 2000-16, October 2000.

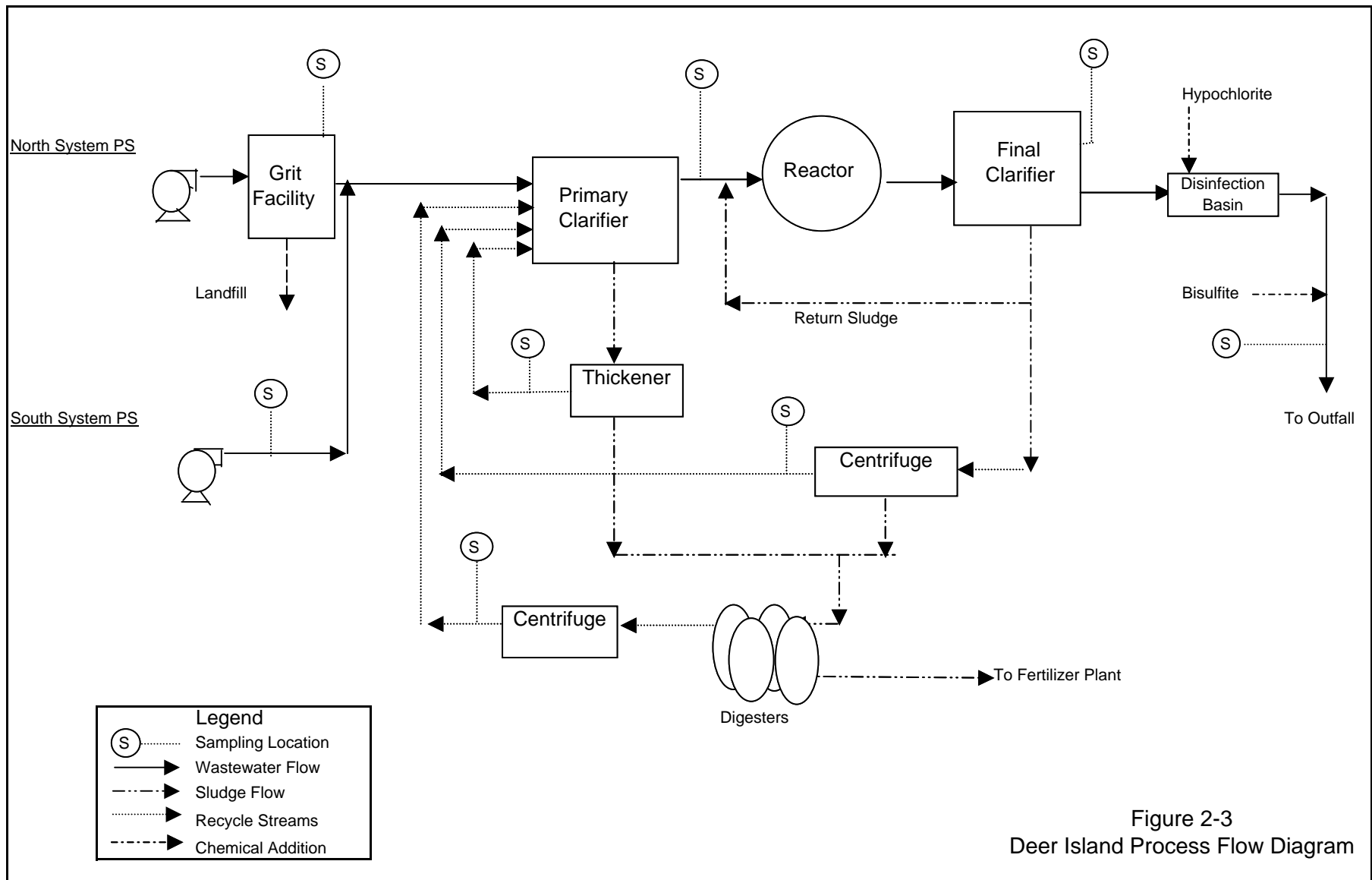

Legend	
(S).....	Sampling Location
————▶	Wastewater Flow
- - - -▶	Sludge Flow
.....▶	Recycle Streams
- - - -▶	Chemical Addition

Figure 2-3  
Deer Island Process Flow Diagram

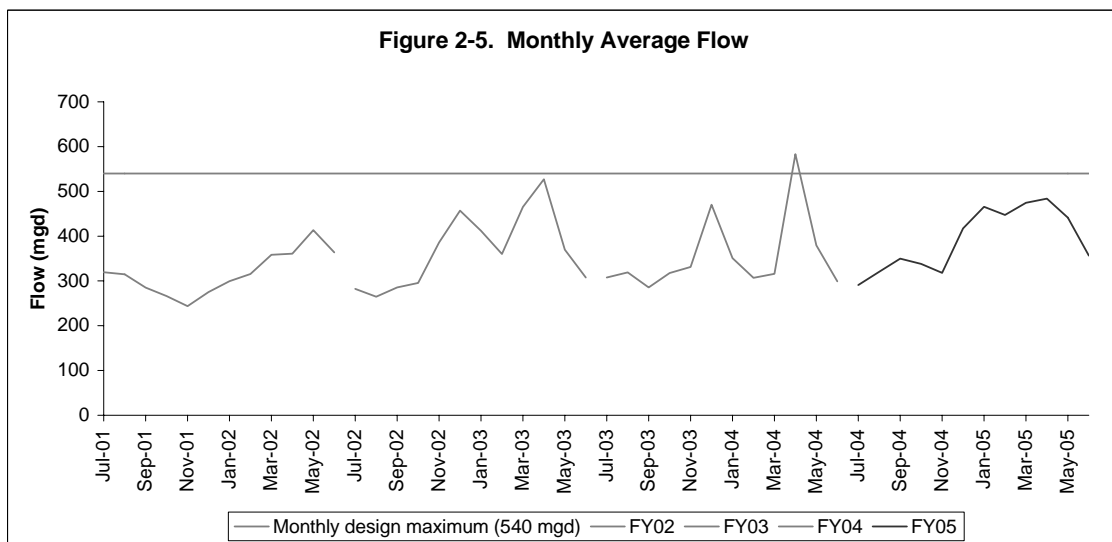
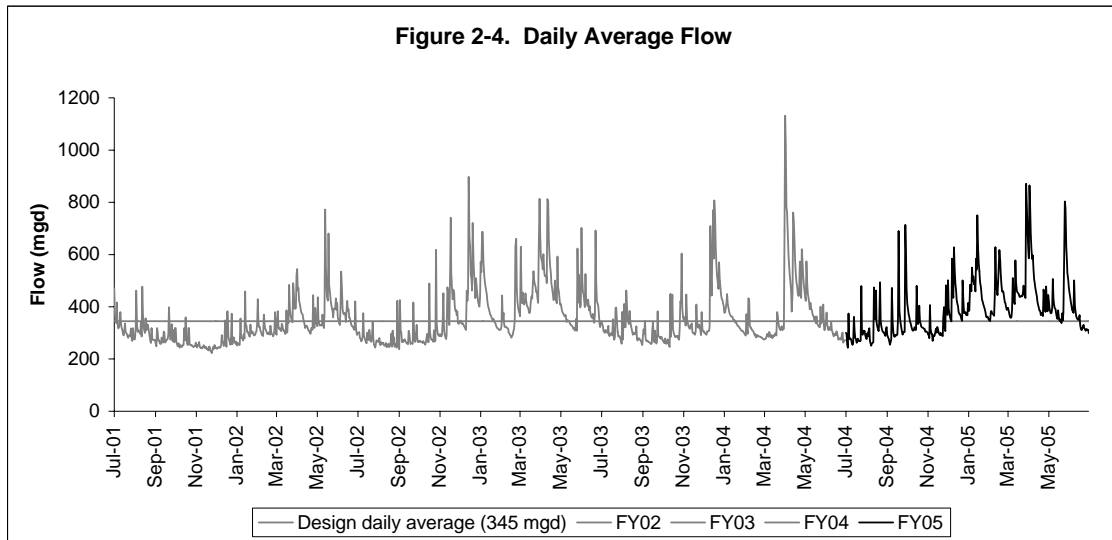

### 2.3.2 Nitrogen Loads

Extensive nitrogen data have been gathered from the nitrogen monitoring program. Whereas past reports used estimated nitrogen loads, actual data are now available to quantify nitrogen in the major waste streams at Deer Island.

Monitored nitrogen species include ammonia-nitrogen ( $\text{NH}_3^-$ ), nitrites ( $\text{NO}_2^-$ ), nitrate ( $\text{NO}_3^-$ ), and total Kjeldahl nitrogen (TKN), all expressed as nitrogen. Total nitrogen (TN) is the sum of TKN,  $\text{NO}_3^-$ , and  $\text{NO}_2^-$ . For each monitoring event, the actual flow for each waste stream is used to derive the daily loads of each nitrogen species. The TN load is determined from these calculated loads.



The flow-weighted Deer Island raw wastewater concentration of ammonia is 20.5 mg/L and TN is 32 mg/L. These concentrations are typical of a medium-strength wastewater.<sup>2</sup> TN load from raw influent is about 94,000 lbs/d.

During the monitoring period of February 2002 to March 2005, return flows from residual processing contributed about 27% of the total nitrogen load to the primary clarifiers. Since April 2005, this percentage dropped to 24 % but the south system flow loads has increased by 12%, reflecting the contribution of the recycle streams that are piped back to the south system.

Monitoring data show that the primary clarifiers remove about 23% of the total nitrogen load (raw and recycle streams). An additional 28% is removed by the activated sludge and secondary settling clarifiers. The overall Deer Island TN removal is about 25%, based solely on raw influent and effluent values. Table 2-2 summarizes the average annual concentrations of monitored nitrogen species of the various wastestreams, including the flow-weighted averages of the combined streams. Also presented are the calculated TN loads.

Figure 2-6 shows TN mass balance across the unit processes at Deer Island. TN results from the monitoring program are very similar to TN results obtained from the theoretical calculated TN. Figure 2-7 shows the monthly average total nitrogen loads to the primary clarifiers, while Figure 2-8 shows the total nitrogen effluent loads out of the primary clarifiers, secondary clarifiers, and final effluent.

---

<sup>2</sup> Metcalf & Eddy, Inc., *Wastewater Engineering: Treatment, Disposal and Reuse*, 3<sup>rd</sup> ed., 1991. p. 109.

**Table 2-2**  
**Summary of Nitrogen Monitoring Results**

Sampling Location	Flow* (mgd)	TKN		NH3-N		NO3-N		NO2-N		NO3/NO2		Total Nitrogen	
		(mg/L)	(lb/d)	(mg/L)	(lb/d)	(mg/L)	(lb/d)	(mg/L)	(lb/d)	(mg/L)	(lb/d)	(mg/L)	(lb/d)
<b>North System Influent</b>													
Minimum	158.6	14.5	26491	6.7	22862	0.00	0	0.00	0	~	~	17	27417
Maximum	829.7	63.0	146436	37.4	89122	2.98	10118	1.60	7461	~	~	63	148018
Average	240.7	32.5	64077	19.8	38794	0.15	384	0.21	486	~	~	33	64946
Standard Deviation	70.1	8.6	16302	5.4	9283	0.36	1099	0.27	789	~	~	8	16387
<b>South System Influent</b>													
Minimum	58.7	12.3	8193	5.8	7321	0.00	0	0.00	0	~	~	13	8193
Maximum	343.1	81.4	93242	138.0	146864	1.71	4301	0.80	1247	~	~	81.4	93249
Average	119.6	30.2	29469	22.0	21407	0.05	99	0.06	80	~	~	30.4	29648
Standard Deviation	43.3	9.9	12834	20.9	22992	0.21	462	0.13	196	~	~	9.7	12972
<b>Calculated Raw Influent</b>													
Minimum	222.7	15.4	48406	8.2	33273	0.00	0	0.00	0	~	~	17.2	49332
Maximum	1132.2	55.3	192363	57.5	178564	1.97	10118	1.32	7479	~	~	55.3	193944
Average	360.3	31.7	92927	20.5	59866	0.13	533	0.17	597	~	~	32.0	93975
Standard Deviation	108.0	6.9	21875	8.0	24838	0.31	1510	0.22	971	~	~	6.7	22368
<b>Recycle Streams**</b>													
Waste sludge centrate													
Minimum	0.01	20	648	7.1	152	~	~	~	~	0.00	0.0	20	648
Maximum	10.72	387	15686	211.0	6576	~	~	~	~	0.20	8.0	387	15686
Average	4.69	137	5020	24.4	918	~	~	~	~	0.02	0.8	137	5021
Standard Deviation	1.57	68	2775	15.4	588	~	~	~	~	0.02	0.9	68	2775
Digested sludge centrate													
Minimum													
Maximum	1.76	6720	36653	2660	21248	~	~	~	~	2.79	19.4	6720	36654
Average	0.75	1816	11405	1319	8348	~	~	~	~	0.08	0.5	1805	11406
Standard Deviation	0.35	742	5916	308	3708	~	~	~	~	0.23	1.6	753	5916
Gravity thickener overflow													
Minimum	0.00	25	515	10	169	~	~	~	~	0.00	0.0	25	515
Maximum	11.13	729	35221	352	18347	~	~	~	~	1.38	66.2	916	35224
Average	5.29	200	8482	61	2713	~	~	~	~	0.03	1.1	205	8483
Standard Deviation	1.75	147	6919	70	3660	~	~	~	~	0.11	5.1	156	6919

**Table 2-2  
Summary of Nitrogen Monitoring Results**

Sampling Location	Flow* (mgd)	TKN		NH3-N		NO3-N		NO2-N		NO3/NO2		Total Nitrogen	
		(mg/L)	(lb/d)	(mg/L)	(lb/d)	(mg/L)	(lb/d)	(mg/L)	(lb/d)	(mg/L)	(lb/d)	(mg/L)	(lb/d)
<b>Calculated Primary Influent**</b>													
Minimum	236.37	16.7	66067	8.6	41124	~	~	~	~	0.00	0.0	18	66067
Maximum	1142.72	57.9	205203	59.9	184762	~	~	~	~	3.08	17598.2	59	214940
Average	371.18	36.3	112615	22.8	70650	~	~	~	~	0.33	1285.9	37	113901
Standard Deviation	107.90	8.0	23162	8.6	26489	~	~	~	~	0.49	2485.9	8	23858
<b>Primary Effluent</b>													
Minimum	230.0	10.0	43209	7.7	40574	~	~	~	~	0.00	0.0	10	43347
Maximum	1150.9	52.8	180481	35.3	126247	~	~	~	~	2.32	13593.5	53	180481
Average	368.6	30.7	90084	21.5	62779	~	~	~	~	0.16	720.2	31	90439
Standard Deviation	113.5	8.3	15329	6.0	10762	~	~	~	~	0.39	1927.7	8	15282
<b>Secondary Effluent</b>													
Minimum	201.9	6.8	16427	7.9	27773	~	~	~	~	0.00	0.0	7	17940
Maximum	1132.2	36.9	130762	38.8	113284	~	~	~	~	4.11	1978.5	38	139634
Average	350.0	22.5	61009	19.5	52734	~	~	~	~	1.54	3416.7	24	65403
Standard Deviation	94.2	5.9	12062	5.2	10252	~	~	~	~	0.59	1881.8	6	11884
<b>Final Effluent</b>													
Minimum	222.4	6.6	35197	4.5	29212	0.0	0	0.0	0	0.0	37	8.9	41696
Maximum	1132.2	35.0	123957	32.0	99738	5.8	22330	4.6	17289	6.3	21307	36.9	125826
Average	370.6	21.6	62162	18.3	52246	1.5	4626	0.5	1650	2.2	6770	23.7	68686
Standard Deviation	114.0	5.8	12145	5.2	8831	1.2	3998	0.7	2642	1.1	4103	5.5	12526

Notes:

- \* Flows reported are averages of the whole sampling period. The flow-weighted concentrations were calculated using flows during sampling events. Average loads are calculated using all the data points.
- ~ No samples collected.
- \*\* Recycle streams sampling commenced in February 2002; the calculated primary influent concentrations therefore only include data for the period February 2002 to June 2005. Since March 2005, digested sludge was piped directly to the Pelletizing Plant.

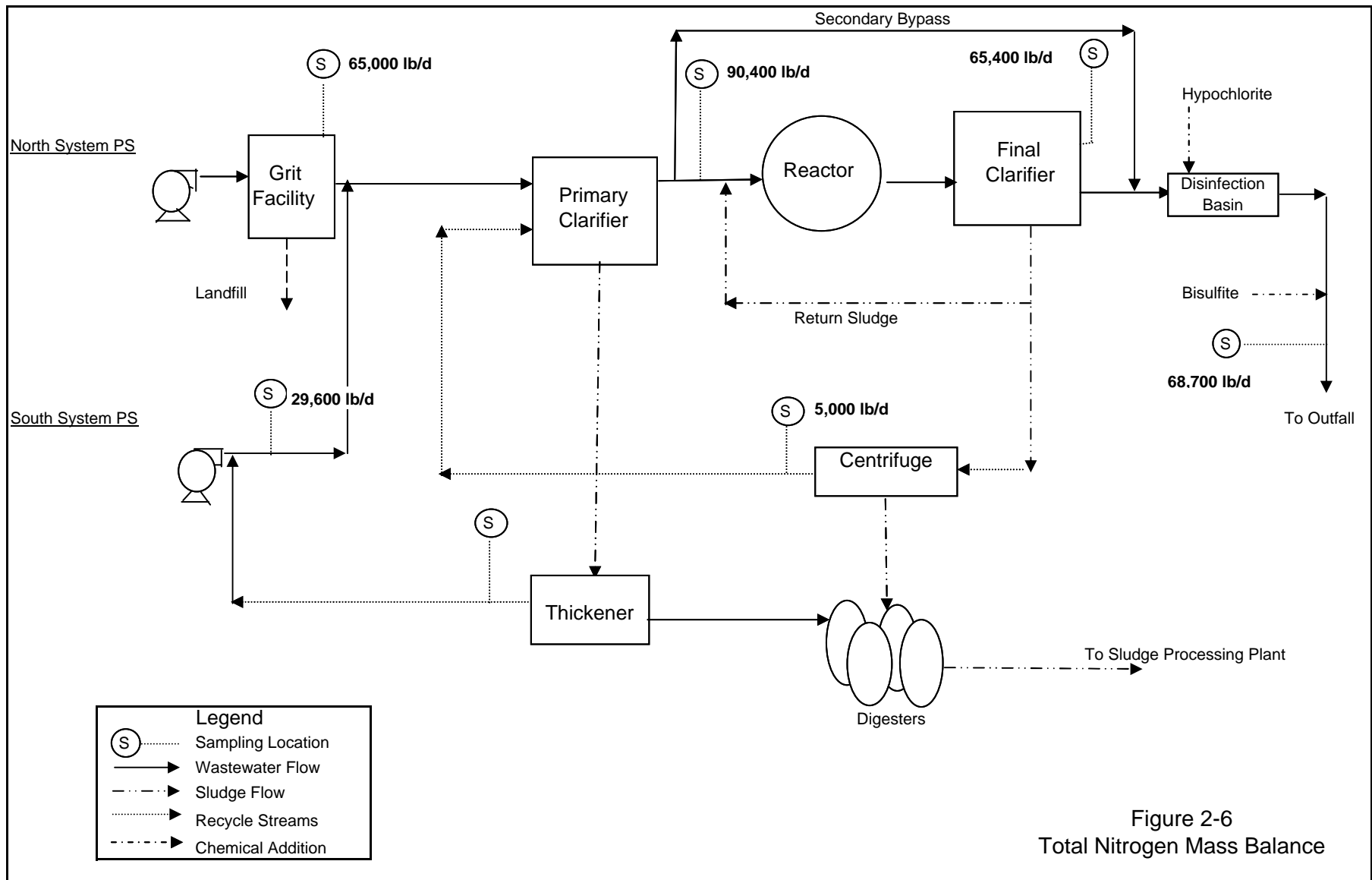

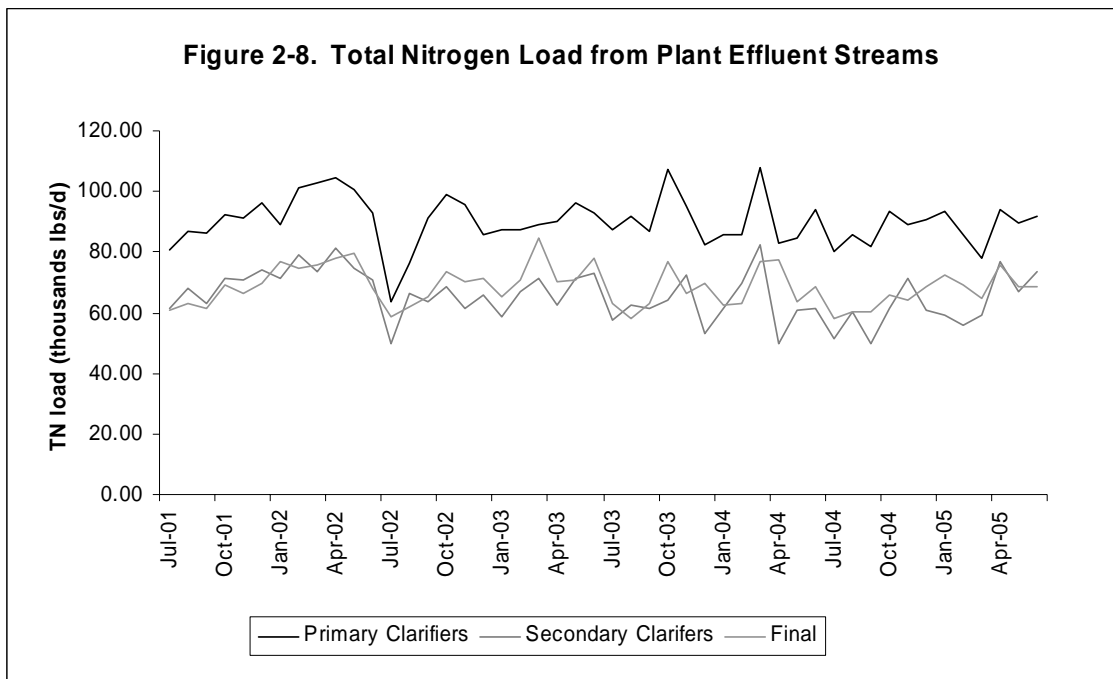
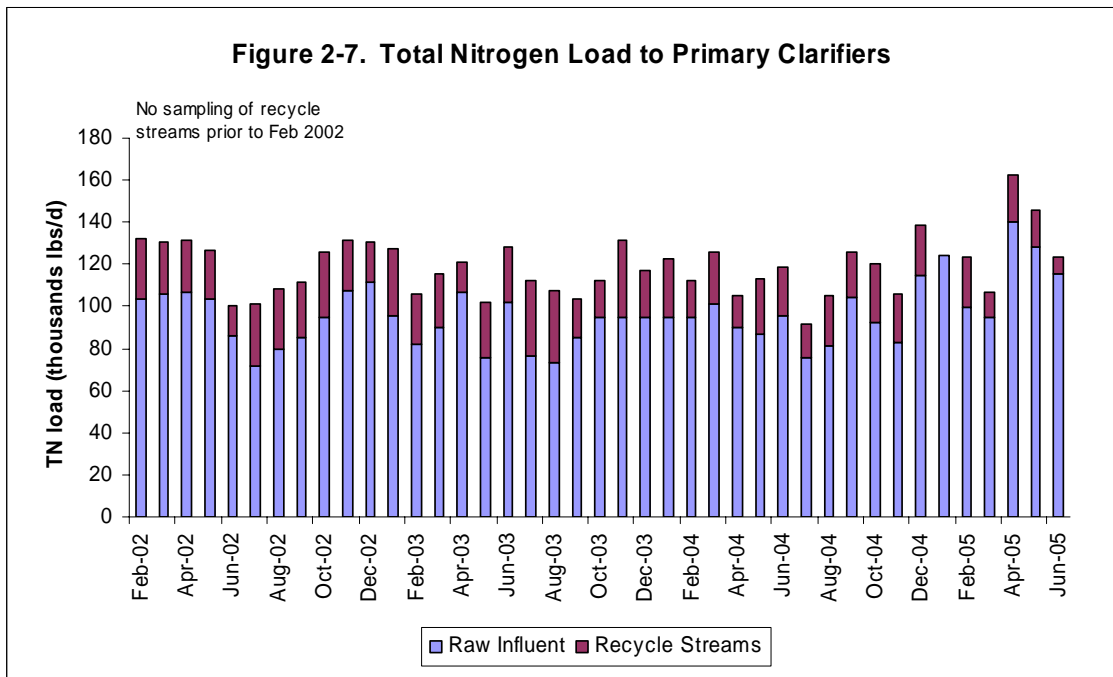

## 2.4 Basic Design Information

To develop a conceptual design for a nitrogen removal system, some basic information is required. This includes ambient temperature, design flows and loads, and the target effluent quality.

### 2.4.1 Wastewater Temperature

Wastewater temperature is important for sizing biological systems for nitrification. As in most biochemical reactions, temperature greatly influences nitrification rates. The rate of ammonium oxidation depends on the growth rate of the bacteria *Nitrosomonas*, which in turn depends on temperature. Based on monitoring data and the possible requirement for year-round nitrification, the report uses the consultant's recommendation of a minimum wastewater temperature of 11°C (51.8°F).<sup>3</sup> Ambient wastewater temperature measurements of the south system influent average about 4°F lower than the north system influent.

Final effluent is probably the best source for determining the ambient temperature in designing a biological nitrogen removal system. There were only three days out of 365 days during FY05 when the temperature dipped below the 51.8°F design criterion. Plant performance would deteriorate during very cold weather but the lessened performance should not cause the plant to exceed its NPDES permit.

Figures 2-9 and 2-10 graph the north and south system influent temperatures, respectively, while Figure 2-11 depicts effluent temperatures during the monitoring period.

### 2.4.2 Design Flows and Nitrogen Loads

Deer Island can provide a maximum-day hydraulic capacity of 780 mgd for secondary treatment. In an earlier study, the maximum flow that could sustain secondary plant operation without polymer addition was 540 mgd. Studies are currently being conducted to determine if a higher flow could sustain secondary treatment. The revised estimate of plant flow capacity however does not affect sizing of units for biological nitrogen treatment, because their design is based on organic and nitrogen loads, rather than on flow, and loads at Deer Island are largely independent of flow.

The design average plant flow of 345 mgd, which is close to the average influent flow of 360 mgd for the monitoring period in Table 2-3, is used for this analysis. Using the design average daily flow and maximum monthly flow of

---

<sup>3</sup> Camp Dresser and McKee, *Technical Survey of Nitrogen Removal Technologies for the Deer Island Treatment Plant*, July 2001.

345 and 540 mgd respectively, the corresponding average loads of nitrogen in primary and in secondary effluent are presented in Table 2-3. Table 2-3 also compares previous load estimates with more current data. As shown, the estimates used in previous reports compare well with actual data.

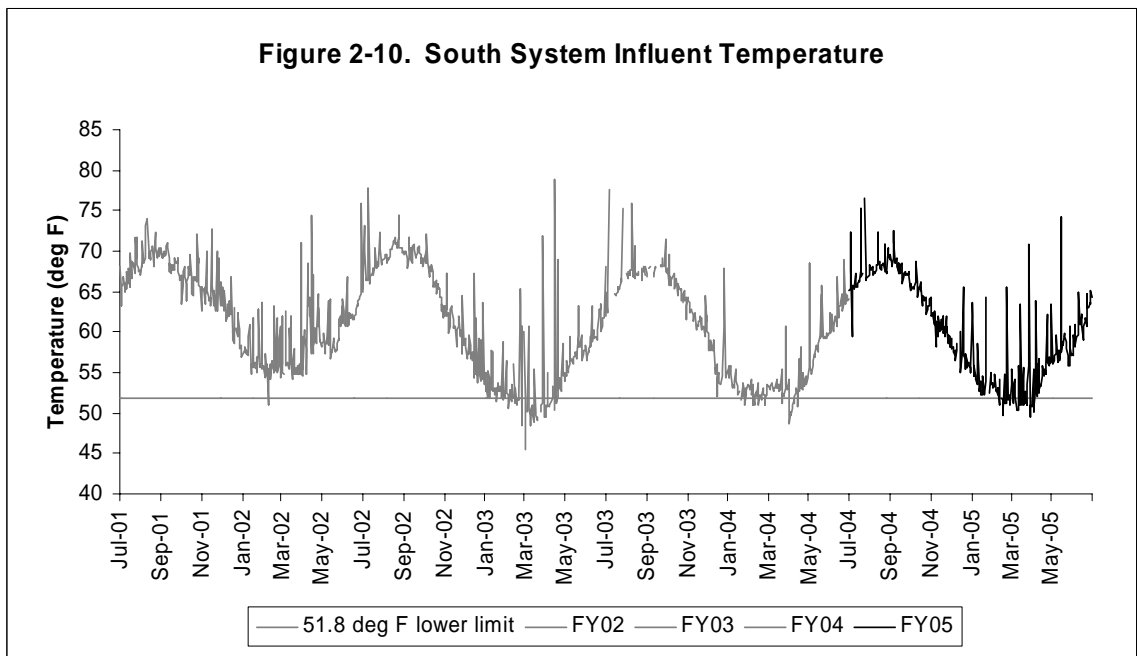
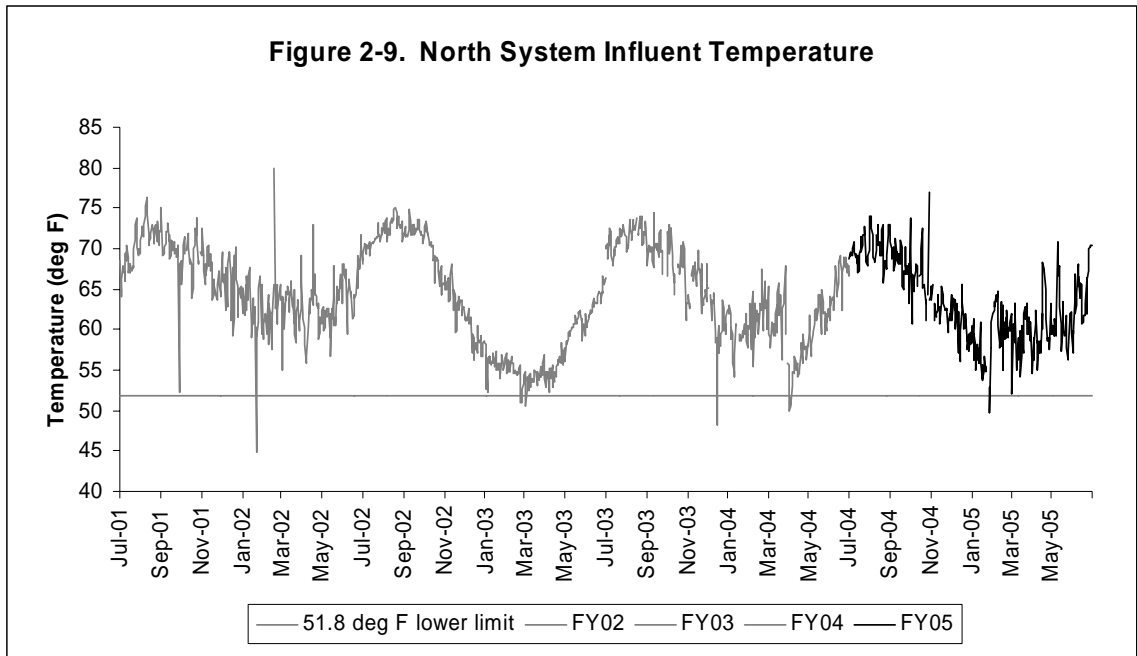

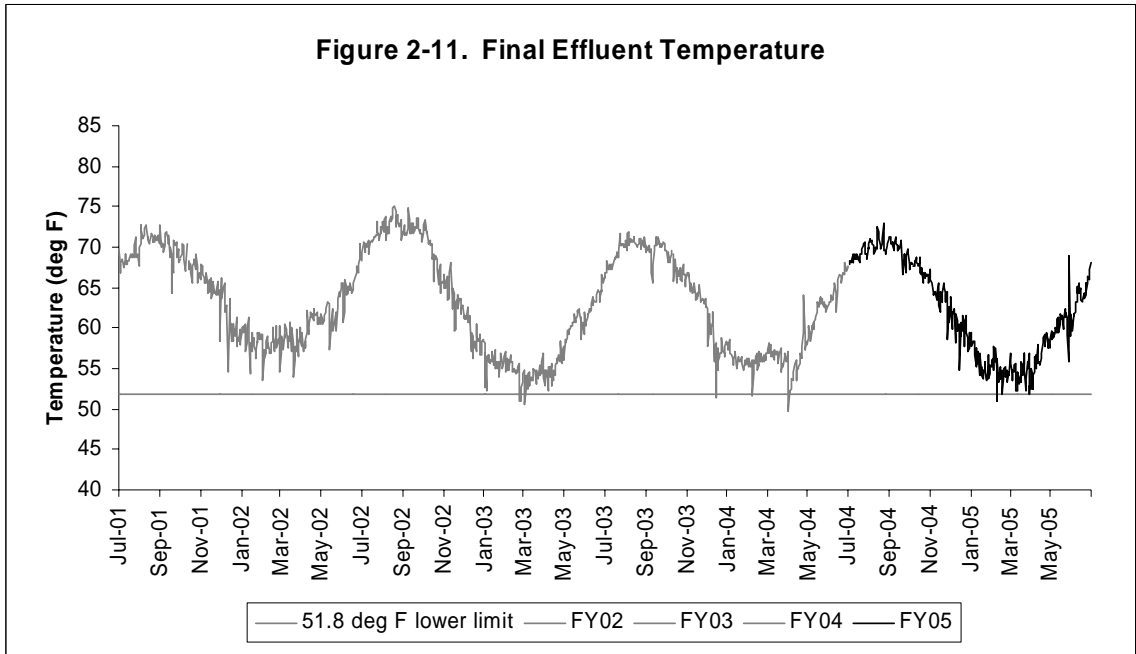

**Table 2-3  
Flows and Nitrogen Loads**

	<i>Flow (mgd)</i>	<i>Primary Effluent Nitrogen Load (lb/d)</i>		<i>Secondary Effluent Nitrogen Load (lb/d)</i>	
		<i>2001*</i>	<i>FY02- FY05</i>	<i>2001*</i>	<i>FY02- FY05</i>
Average – Day	345	80,600	90,400	66,200	65,400
Max – Month	540	104,700†	107,600	86,000†	81,500

\* Based on limited monitoring data (July-December 1999) and estimated total nitrogen loads from residuals processing recycle flows.

† Estimated.

### 2.4.3 Required Effluent Quality

Limits for nitrogen in effluent from Deer Island have not been set. This evaluation considers two levels of effluent quality: 4 mg/L and 8 mg/L of total nitrogen, both year-round. These concentrations reflect typical effluent standards for nitrogen. Conceptual land requirements and site layouts are conservatively based on the lower effluent limit because it requires more space for nitrogen removal.



## Section 3

# Screening of Alternatives

This section identifies processes available to remove nitrogen from wastewater and screens them to generate a list of alternatives appropriate for further evaluation. Table 3-1 summarizes the alternatives, and Section 4 examines them in detail.

Nitrogen removal technologies fall into three basic camps: physical/chemical processes, biological processes, and hybrids of the two.

### 3.1 Physical/Chemical Processes

Physical/chemical processes rely on basic chemical reactions to remove nitrogen species. Physical/chemical processes employed for nitrogen removal include reverse osmosis, ammonia stripping, ion exchange, and breakpoint chlorination.

Reverse osmosis is expensive and requires a high degree of pretreatment; its use is not necessary to achieve potential nitrogen standards at Deer Island.

Ammonia stripping requires addition of lime to raise the pH of wastewater to about 11. At this pH, ammonia is present as a gas, rather than as the ammonium ion. The limed wastewater is sprayed over a packing material, with air added counter current to the liquid flow to strip the ammonia gas. A problem with this alternative is that power requirements and ammonia emissions are high, and the calcium carbonate scale that forms on the packing requires a high level of maintenance.

In ion exchange, wastewater is passed through a bed of material that exchanges sodium or potassium in the exchange material for the ammonium ion in wastewater. When the ion-exchange material becomes exhausted, passing a caustic solution through the bed regenerates it. Regeneration releases the adsorbed ammonium ions, which are collected in the exhaust solution. Ammonia in the exhaust can be recovered for use as a fertilizer. A problem with ion exchange is high operation and maintenance costs and headloss resulting from suspended solids build-up on the resin.

With breakpoint chlorination, chlorine at high doses oxidizes ammonia nitrogen to nitrogen gas. Dechlorination is needed after breakpoint chlorination, and volatile organic compounds such as chloroform and other trihalomethanes are formed. Breakpoint chlorination must be preceded by treatment beyond secondary treatment, typically coagulation, settling, and filtration, thus making it most effective on polished effluents. A problem with this alternative is that the chlorine demand will be too great to allow for cost-effective implementation.

Physical/chemical processes remove nitrogen only in the ammonia form. They do not remove organic nitrogen or nitrite and nitrate. They have never been used extensively, and their use is declining, so there are few plants now using physical/chemical processes for nitrogen removal. Physical/chemical processes are judged to be inappropriate for use at Deer Island.

## **3.2 Biological Processes**

Biological nitrogen removal involves two processes in sequence: nitrification in an aerobic environment and denitrification in the absence of oxygen. In nitrification, ammonia is oxidized to nitrite and then to nitrate. In denitrification, nitrate is reduced to nitrogen gas. For denitrification to occur at an appreciable rate, suitable concentrations of organic material must be present. In some configurations, the organic matter present in the wastewater is sufficient for denitrification to occur. For other configurations, a supplementary source, such as methanol, must be provided.

Processes available for biological nitrification and denitrification include suspended-growth systems, fixed-film systems, and hybrid systems. In hybrid systems, fixed-film material is added to the aeration tank of suspended-growth systems.

### **3.2.1 Suspended Growth Systems**

Deer Island uses the activated-sludge process to provide secondary treatment. The activated sludge units at Deer Island include aeration tanks and secondary clarifiers. Options for use of the activated sludge process for nitrogen removal at Deer Island include:

- Sequencing batch reactors;
- Membrane activated sludge systems;
- Two-stage activated sludge; and
- Single-stage activated sludge.

#### **Sequencing Batch Reactors**

Sequencing batch reactors combine biological activity and settling in a single tank, rather than separating these functions in an aeration tank and a clarifier. They do not save space, however, and control and piping become complicated for large facilities. They are not evaluated further in this report.

#### **Membrane Activated Sludge Systems**

Membrane activated sludge systems use membranes to separate effluent from biomass, instead of clarifiers. Their advantage is that the concentration of mixed liquor in aeration tanks can be much higher than with conventional

activated sludge. With higher concentrations, the volume of aeration tanks can be decreased. Membrane activated sludge systems have not been used at plants larger than about one mgd, however. Membrane activated sludge systems are not further evaluated in this report.

### **Two-Stage Activated Sludge**

When activated sludge systems were first used for nitrification, they were designed and built as two-stage systems, with the first stage designed to remove biochemical oxygen demand and the second stage designed to oxidize ammonia. It is now recognized that single-stage nitrification is feasible, and, except for special cases, today's treatment plants feature single-stage nitrification.

At Deer Island, two-stage nitrification would require construction of aeration tanks and clarifiers after the existing units. There is not enough space remaining to build these units, and two-stage nitrification is thus impractical.

### **Single-Stage Activated Sludge**

Nitrification and denitrification can be obtained in a single-sludge system, such as the Modified Ludzack-Ettinger (MLE) process and step feed variation of the activated-sludge process. The MLE process modifies an aeration tank of an activated sludge system by incorporating an anoxic zone ahead of an aeration section designed to provide nitrification. Mixed liquor, which contains nitrate, is returned to the anoxic zone, and nitrate is reduced to nitrogen gas. The step-feed process can achieve denitrification by providing alternating anoxic and aerobic zones. This process has been used successfully in New York City.

To provide nitrification in cold weather (when the wastewater temperature can be 11°C or colder), the solids retention time (SRT) would have to be increased to about 11 days. Current design provides for an SRT of less than 3 days. So, more aeration tanks would be needed. An aeration volume equal to about seven of the existing three aeration batteries would be required. The area required (about ten acres) exceeds the space available with reasonable geometry and this option is dropped from further evaluation. Addition of an anoxic zone would require even more area. No additional clarifiers would need to be constructed, however, because flows would not increase.

## **3.2.2 Fixed Growth Systems**

In fixed-film systems, the biological organisms grow on a supporting surface, in contrast to suspended-growth systems, where the organisms grow in a liquid phase and then have to be separated from effluent in clarifiers. Fixed film systems include rotating biological contactors, nitrifying trickling filters,

biological aerated filters and submerged packed-bed reactors, fluidized bed reactors, and moving bed biofilm reactors.

#### **Rotating Biological Contactors**

Rotating biological contactors (RBCs) consist of disks rotating on shafts arranged so that all or part of the disks are submerged. Excessive growth sloughs from the disks and is captured in clarifiers. For aerobic treatment, the disks are submerged to about 40% of their diameter. For denitrification, the disks are completely submerged. Mechanical reliability of RBCs can be a problem and RBCs are not often used at large treatment plants. Therefore, RBCs will not be reviewed further in this report.

#### **Trickling Filters**

Trickling filters can be used for nitrification after BOD removal, sometimes without the need for settling tanks. A preliminary comparison of the area required for trickling filters and of space available at Deer Island showed that space is insufficient. Additional odor control may be required for trickling filters. Nitrifying trickling filters will not be reviewed further.

#### **Submerged Packed-Bed Reactors**

Submerged packed-bed reactors are similar in configuration to biological aerated filters. They are not provided with aeration, however, and methanol is usually added to the feed stream to provide a carbon source. Like biological aerated filters, submerged packed-bed reactors require backwashing to remove trapped solids and excess biological growth. In the 1997 report, submerged packed-bed reactors were considered separately from deep-bed filters. Because of their common features, these two systems are treated as one in this report. As in the 1997 report, submerged packed beds are further evaluated.

Nitrification and denitrification can be achieved in a single packed-bed that combines the features of a biological aerated filter and of a submerged packed-bed reactor. In this type of reactor, the packed-bed is about three meters deep. The diffusers are set at about two meters beneath the surface, so that the lower section is not aerated and denitrification takes place in the lower section. Methanol is required with secondary effluent because secondary effluent does not contain enough carbon for denitrification to proceed sufficiently. This combined nitrification/denitrification process has not been attempted at large plants and is not retained for further evaluation.

#### **Fluidized-Bed Reactors**

Fluidized-bed reactors are tanks filled with 4 to 10 feet of sand or other medium to support the growth of biomass. Wastewater is fed from the bottom of the reactor at a velocity high enough to fluidize the bed. (This contrasts

with biological aerated filters, where the bed is not fluidized during normal operation.) Excessive growth shears from the medium and is separated from treated effluent in an upper zone of the reactor. These units were evaluated in the 1997 report for nitrification and for denitrification. The system supplier now believes that other options are preferred for nitrification, and fluidized-bed reactors are not retained for further study for nitrification. Fluidized-bed reactors are retained, however, for denitrification.

### **Moving-Bed Biofilm Reactors**

The moving-bed biofilm reactor (MBBR) process consists of a tank filled with small plastic elements. The hollow cylindrical elements are about 1 cm in all dimensions and have ridges on the exterior and a crosspiece on the inside. A clarifier is required to separate excess growth. With air addition, MBBR can be used for nitrification. With methanol addition, the process can be used for denitrification. This process is recommended for further evaluation.

### **Biological Aerated Filters**

Biological aerated filters (BAFs) consist of fully submerged, stationary beds of medium about 3 or 4 mm in diameter. Flow through the system is usually upward (although there are some downflow systems), and air diffusers are placed at the bottom of the filter. Periodically, the filters are backwashed to remove accumulated solids. The backwash water requires treatment and is usually returned to the main wastewater flow after settling. BAFs were evaluated in the 1997 report, and are retained here for further evaluation.

## **3.2.3 Hybrid Systems**

Hybrid systems are sometimes called integrated fixed-film activated sludge systems. The fixed-film material placed in the suspended-growth tanks includes ropes, sponges, trickling filter media, RBCs and the media used for MBBR. These materials could be placed in the existing aeration tanks and increase their capacity. Capacity is increased because biomass grows on the fixed-film material as well as in the suspended phase. The 1997 report noted that more experience would be needed before the option could be recommended. Since then, additional information has become available, but rates for nitrification still need further research (Sen *et al* 2000).<sup>1</sup> This report does not further evaluate hybrid systems, but they should be considered if MWRA decides to conduct pilot tests of alternative nitrification systems. Pilot testing could be used to determine appropriate design criteria.

---

<sup>1</sup>Sen, D., *et al.*, *Investigation of Hybrid Systems for Enhanced Nutrient Control*, Project 96-CTS-4, Water Environment Research Foundation, 2000.

**Table 3-1  
Alternatives for Controlling Nitrogen at the Deer Island Treatment Plant**

	<b>Total Nitrogen Removal</b>
<b>Physical/Chemical Processes</b>	
Ammonia Stripping	X
Ion Exchange	X
Breakpoint Chlorination	X
Reverse Osmosis	X

	<b>Nitrification</b>	<b>Denitrification</b>
<b>Biological Processes</b>		
Suspended Growth		
Sequencing Batch Reactors	X	X
Membrane Activated Sludge	X	X
Single Stage and Two Stage	X	X
Fixed Film		
Rotating Biological Contactor	X	X
Nitrifying Trickling Filter	X	
Biological Aerated Filters	X	
Fluidized-Bed Reactors		X
Submerged Packed-Bed Reactor		X
Moving-Bed Biological Reactor	X	X
Hybrid Systems		
Rope Media	X	X
Sponge Media	X	X
Trickling-Filter Media	X	X
Rotating Biological Contactor	X	X
MBBR Media	X	X

### 3.3 Systems Retained for Further Evaluation

Table 3-2 shows systems retained for further evaluation. These systems were chosen based on ability to handle the flows and nitrogen loads at Deer Island, as well as experience with cost, reliability, and ability to fit into the available land at the treatment plant.

**Table 3-2**  
**Systems for Further Evaluation**

	<i><b>Nitrification</b></i>	<i><b>Denitrification</b></i>
Biological Aerated Filters	X	
Submerged Packed Bed Reactors		X
Fluidized-Bed Reactors		X
Moving Bed Biofilm Reactor	X	X

## Section 4

# Evaluation of Alternatives

This section investigates the alternatives proposed in Section 3 for further evaluation. They are grouped into these process alternatives:

- Biological aerated filters for nitrification with  
Submerged packed-bed reactors for denitrification
- Biological aerated filters for nitrification with  
Fluidized-bed reactors for denitrification
- Moving-bed biofilm reactors for nitrification and denitrification

Development of the alternatives includes selection of criteria for sizing units and preliminary sizing of components. Alternatives are developed to meet standards of 4 mg/L and 8 mg/L of effluent nitrogen, but are designed conservatively to meet effluent levels of 3 mg/L and 6 mg/L, respectively.

Based on information provided, MWRA's consultant was able to obtain information about proprietary equipment and processes from system suppliers. Recommendations from the suppliers were reviewed, and professional judgment and experience were applied to select design criteria. The units provided allow for standby, such as for backwashing or other maintenance and for repair.

Oxygen requirements, chemical requirements, and sludge production for each alternative would be about equal. Those needs are covered in Section 4.4.

### 4.1 Biological Aerated Filters and Submerged Packed-Bed Reactors

Design criteria for nitrification in biological aerated filters (BAFs) and denitrification in submerged packed-bed reactors (SPBRs) are shown on Table 4-1. Two major suppliers provided recommendations for the criteria: Infilco Degremont, Inc., and Kruger, Inc. On the table, the number of units needed to meet nitrogen loads is calculated, based on loading criteria and on unit dimensions.

The table shows that 96 BAFs and 28 SPBRs would be required. These include standby units. To fit on the space available, the units would have to be constructed on two levels. Each level would include half of the units, plus blowers and other ancillary facilities.



To reach the new facilities, secondary effluent, which now flows to an effluent channel south of the secondary clarifiers, would be diverted to a new effluent channel north of the clarifiers and to a new pumping station to lift flow to the new facilities. Effluent from the new facilities would enter a new tunnel discharging to the chlorine contact tanks.

Blowers would provide aeration. The air would be injected at the base of each biological aerated filter and flow upward, co-current with the wastewater flow.

The BAFs and SPBRs both need to be backwashed approximately every two days, using final effluent for backwashing. Backwash waste would be returned to the head of the secondary system or to the head of the plant. Backwash rate is about 25 gpm/ft<sup>2</sup>, for about eight minutes. Air required for backwashing is approximately 5000 scfm/cell.

The gross area required for siting the BAF and SPBR system, including blowers, a pump station and galleries would be about 5.7 acres, the entire available space in the area of secondary Battery D. Figure 4-1 shows the proposed BAF and SPBR layout.

## **4.2 Biological Aerated Filters and Fluidized-Bed Reactors**

The BAF design for this treatment combination would be identical to that described in Section 4.1. Table 4-2 summarizes sizing information for the fluidized bed reactors (FBRs) for denitrification. The FBR design is based on information provided by US Filter. The effluent from the fluidized beds would flow to the chlorine disinfection basin and then be discharged from the facility.

The area requirements for the BAF/FBR system would be approximately 7 acres. This area exceeds the space available in Battery D, but the proposed layout can be incorporated as shown in Figure 4-2.

## **4.3 Moving-Bed Biofilm Reactors**

For this option, Kaldnes provided the design concept criteria. Media would be added to the existing aeration tanks, where nitrification would occur.

Table 4-3 summarizes design criteria for the MBBR nitrification system and Table 4-4 summarizes the MBBR denitrification system. Because the MBBRs would be treating primary effluent, the analysis for MBBRs accounted for nitrogen removed via assimilation into the biomass produced during BOD removal. In the proposed MBBR systems, polyethylene media would be added to the existing aeration tanks. The biomass for biological treatment would grow on the media, thus eliminating the need for recycling solids from the secondary clarifiers. Stainless steel sieves would be installed at the outlets of the aeration basins to retain the media.

**Table 4-1  
 Biological Aerated Filter for Nitrification and  
 Submerged Packed-Bed Reactors for Denitrification**

	<b><i>BAF Nitrification</i></b>	<b><i>SPBR Denitrification</i></b>
TKN Load (lb/d) Maximum Month	81,520	81,520
Nitrogen Loading Rate Allowed (lb/d/1,000ft <sup>3</sup> )	40	190
Hydraulic Loading Rate Allowed (gpm/ft <sup>2</sup> )	4	15
Unit Dimensions		
Depth (ft)	12.1	9.5
Surface Area (ft <sup>2</sup> )	1,940	1,940
Volume (ft <sup>3</sup> )	23,474	18,430
Active Units	88	24
Units Provided	96	28

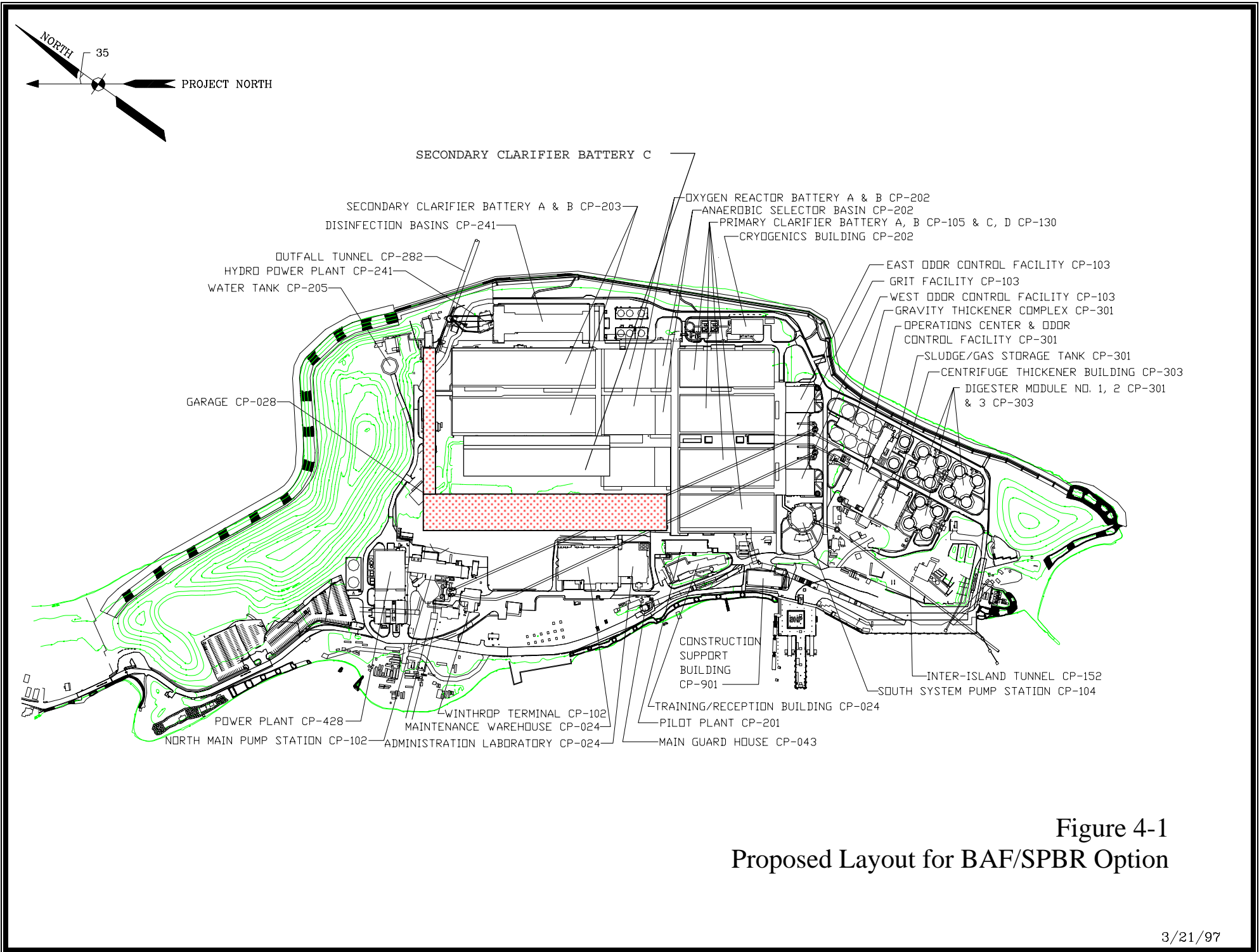

Figure 4-1  
Proposed Layout for BAF/SPBR Option

**Table 4-2**  
**Biological Aerated Filter for Nitrification and**  
**Fluidized Bed Reactors for Denitrification**

	<b><i>BAF</i></b> <b><i>Nitrification</i></b>	<b><i>FBR</i></b> <b><i>Denitrification</i></b>
TKN Load (lb/d)		
Maximum Month	81,520	81,520
Nitrogen Loading Rate Allowed (lb/d/1,000ft <sup>3</sup> )	40	250
Hydraulic Loading Rate Allowed (gpm/ft <sup>2</sup> )	4	18
Unit Dimensions		
Depth (ft)	12.1	10
Surface Area (ft <sup>2</sup> )	1,940	800
Volume (ft <sup>3</sup> )	23,474	8,000
Active Units	88	41
Units Provided	96	48

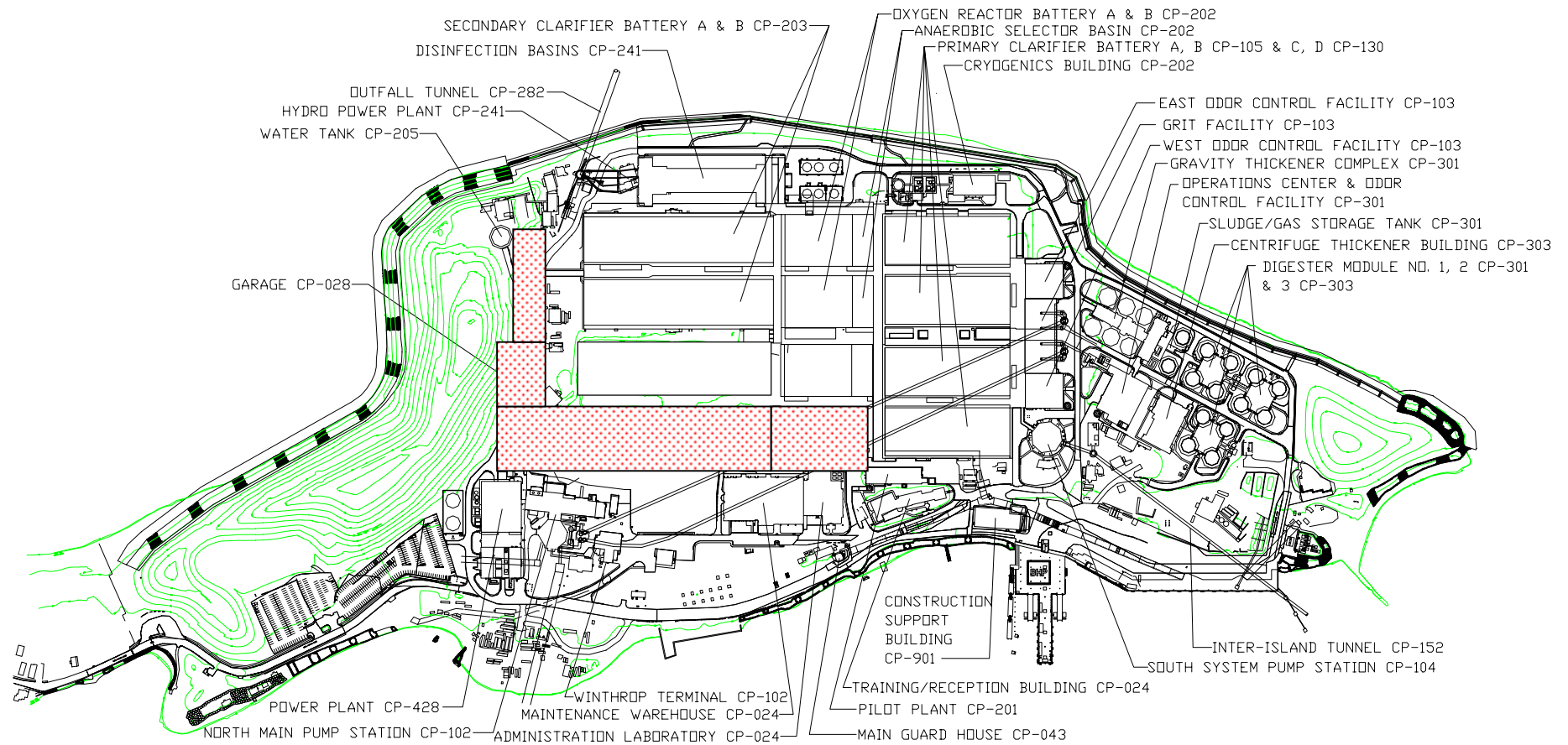
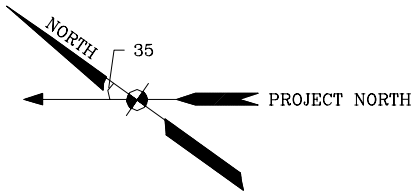

Figure 4-2  
Proposed Layout for BAF/FBR Option

The existing on-site pure oxygen aeration system would provide oxygen and mixing. Because the aeration basins would now provide nitrification as well as oxidation of BOD, additional tankage, as described in Table 4-3, would be required to handle the design flows. Additional facilities for producing oxygen would also be required.

Effluent from the aeration basins would be deaerated before flowing to additional MBBRs for denitrification. Deaeration can be accomplished by nitrogen stripping, which drives dissolved oxygen from the wastewater. Nitrogen gas is a by-product of the cryogenic pure-oxygen generation system. This excess nitrogen can possibly be used as the nitrogen stripping source.

New effluent channels would be required to divert flow from the aeration basins to the denitrification MBBRs and then to the existing secondary settling basins for clarification.

For aeration, approximately 4,800,000 ft<sup>3</sup> of new tanks would be required. The existing aeration basins provide 4,321,800 ft<sup>3</sup>. However, with the need to construct two new channels, 485,100 ft<sup>3</sup> of aeration volume would be lost from the existing basins. The total new volume required (963,300 ft<sup>3</sup>) could be located in the space previously allotted for aeration Battery D.

Denitrification would require between 2,100,000 to 2,500,000 ft<sup>3</sup> of new construction depending on the level of effluent nitrogen concentration to be met. Prior to denitrification, 152,000 ft<sup>3</sup> of deaeration tankage is required to remove dissolved oxygen from the wastewater. Deaeration/denitrification facilities can also be sited in the space previously allocated for secondary clarifier Battery D. Methanol facilities for denitrification would be located between the vehicle maintenance building and the dry storage warehouse.

The proposed MBBR nitrification/denitrification system would require about 6.3 acres. Figure 4-3 shows the conceptual layout of the MBBR nitrification/denitrification system.

**Table 4-3**  
**Moving Bed Biofilm Reactor for Nitrification**

	<b>MBBR for Nitrification</b>
Nitrogen Load in Primary Effluent (lb/d)	
Maximum Month	107,500
Nitrogen Assimilated Plus Ammonia Nitrogen in Effluent (lb/d)	20,000
Nitrogen Nitrified (lb/d)	90,000
Nitrification Rate (g/m <sup>2</sup> ·d)	0.931
Specific Surface Area (m <sup>2</sup> /m <sup>3</sup> )	500
Total Media Required (ft <sup>3</sup> )	3,100,000
% Fill of Carrier Elements	65%
Total Volume Required (ft <sup>3</sup> )	4,770,000
Total Existing Aerobic Tank Volume (ft <sup>3</sup> )	4,321,800
Volume Lost to New Channel (ft <sup>3</sup> )	459,000
New Volume Provided (ft <sup>3</sup> )	935,000
Unit Dimensions of New Basins	
Depth (ft)	24.5
Surface Area (ft <sup>2</sup> )	4,900
Number of Basins	12

**Table 4-4**  
**Moving Bed Biofilm Reactor for Denitrification**

	<i>MBBR for Denitrification</i>	
	<i>4 mg/L Total Nitrogen</i>	<i>8 mg/L Total Nitrogen</i>
Total Nitrate Nitrogen Reduced (lb/d)	76,500	63,000
Loading Rate (g/m <sup>2</sup> -d)	2.45	2.45
Specific Surface Area (m <sup>2</sup> /m <sup>3</sup> )	500	500
Media Required (ft <sup>3</sup> )	1,000,000	825,000
% Fill of Carrier Elements	40%	40%
Total Tank Volume (ft <sup>3</sup> )	2,500,000	2,000,000
Deaeration Volume	152,000	152,000
Tank Dimensions		
Surface Area (ft <sup>2</sup> )	5,929	5,929
Depth (ft)	24.5	24.5
Number of Reactors	18	14



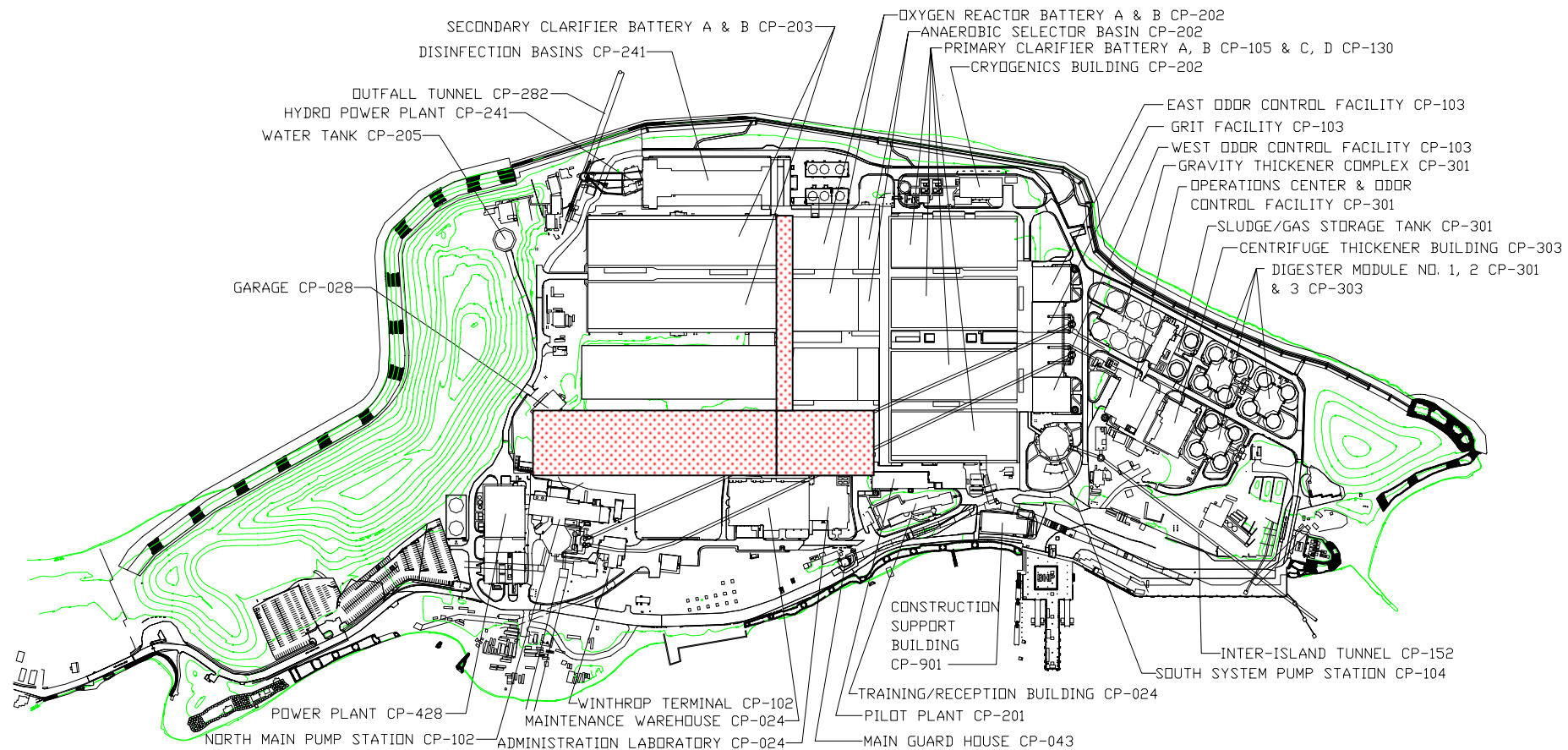
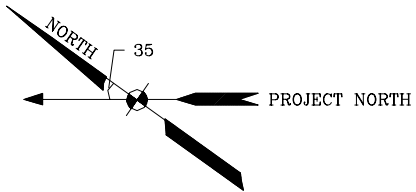

Figure 4-3  
Proposed Layout for Nitrification/Denitrification MBBR Option

## 4.4 Common Elements

Elements common to the three alternatives include oxygen required for nitrification, chemical required for denitrification and additional capacity for processing sludge produced from both nitrification and denitrification systems.

### 4.4.1 Oxygen Requirement

Nitrification will increase the requirement for oxygen. This section examines two alternatives for providing oxygen.

The first case is for the BAF system, which would process secondary effluent from the existing activated-sludge system and for which air from the atmosphere would be used to provide oxygen. In that case, blowers provided by the system supplier would provide diffused air. The blowers would be housed in the BAF building. During the maximum day, about 280 tons/day of oxygen would be needed. Air use would be about 150,000 cfm at the maximum rate, and connected power for the blowers would be about 7,500 horsepower.

The second case is for the MBBR system, which would process primary effluent. With the MBBR system, high-purity oxygen would be used. Two new 150-ton units would have to be added, to supplement the two 150-ton/day units existing at Deer Island's cryogenic plant.

### 4.4.2 Chemical Requirements

Denitrification would require addition of methanol. The methanol requirement assumed for all of the denitrification systems is 3 lb methanol per lb of nitrate-nitrogen reduced. Methanol consumption for denitrification would average about 189,000 lb/d for less than 8 mg/L effluent TN concentration and 228,000 lb/d for an effluent TN concentration of less than 4 mg/L at maximum month flows. Two 243,000 gallon methanol storage tanks would be required. Each tank would provide about 14 days of storage.

### 4.4.3 Sludge Processing

Methanol addition would increase sludge production at the rate of about 0.6 lb/lb of nitrate nitrogen reduced. About 76,000 lb/d of nitrogen would be reduced to achieve 4 mg/L of total nitrogen during the maximum month, and about 45,600 lb/d of additional sludge would thus be produced.

The additional sludge produced would impact thickening of biological sludge and sludge digestion. At a concentration of about 0.6%, additional sludge to be thickened would amount to about 640 gpm. The existing centrifuges have capacity to process the added flow.

The design concentration of thickened biological sludge is 5% and the digesters are sized to provide 15 days of storage at the maximum month. Under these conditions, about 2 million gallons of digestion capacity would be needed. Based on current operating practices, the digesters have enough capacity to handle the additional sludge flow.

## 4.5 Recommendations for Future Considerations

Biological nitrogen removal technologies appear to be the most cost-effective method of nitrogen removal at this time. In the spring of 2003, the Water Environment Research Foundation research project *Sustainable Technology for Achieving Very Low Nitrogen and Phosphorus Effluent Levels*<sup>1</sup> commenced. This 2-year project will assess a variety of technologies to develop information about the feasibility and cost benefits of nutrient reduction. MWRA will monitor the progress of this study for consideration at Deer Island. Additional considerations in the selection of alternative options include separate treatment of residual processing return flows at Fore River, decreasing methanol requirements, and utilizing the existing pilot plant to study nitrification rates.

### 4.5.1 Separate Treatment at the Residuals Processing Plant

Since April 2005, digested sludge is sent to the Residuals Pelletizing Plant in Quincy via the inter-island tunnel. With all processing of digested sludge taking place at the plant, sidestreams from thickening and dewatering digested sludge contain high concentrations of ammonia, and it might be economical to treat the sidestreams for nitrogen removal at the facility. Treatment at the Residuals Processing Plant therefore may decrease the size of facilities needed at Deer Island.

### 4.5.2 Decreasing Requirement for Methanol

All the alternatives considered in Section 4 would require addition of methanol as a carbon source for denitrification. With these options, purchase of methanol would be a major expense. Applying treatment processes that use wastewater to provide the carbon source would decrease use of methanol.

Section 3.2.1 described the Modified Ludzack-Ettinger (MLE) process, which is a modification of the activated sludge process. In that section, it was stated that the MLE process and other modifications of the activated sludge process require more space than is available at Deer Island. The volume (and hence, space) required can be decreased by adding carrier material to the system, to serve as medium on which dense biological growth could be supported. The carrier material could be used to support a fixed film (as discussed in Section 3.2.2) or could be a hybrid system (as discussed in Section 3.2.3). Additional

---

<sup>1</sup> Water Environment Research Foundation, *Progress*, vol. 14(2), Spring 2003.

work would be required to assess the kinetics of these systems and to determine how to configure tanks and piping at Deer Island.

#### **4.5.3 Testing at Pilot Plant**

The pilot plant at Deer Island was used successfully during the DP-29 study to examine the operation of activated sludge systems. Thought will be given to using the pilot plant to determine kinetics of alternative processes for nitrification and denitrification. The facilities could be used, for example, to determine design requirements for systems that would decrease requirements for methanol (see Section 4.5.2 for description). With a pilot-plant study conducted, design of facilities for nitrogen removal could be more efficient.



Massachusetts Water Resources Authority  
Charlestown Navy Yard  
100 First Avenue  
Boston, MA 02129  
(617) 242-6000  
<http://www.mwra.state.ma.us>